



RICOH

RDC-7

Image Capturing Device

Operation Manual

To ensure correct use of your digital camera, read this manual carefully before use. Keep the manual handy for future reference.

Introduction

Thank you for purchasing a Ricoh digital camera. This manual explains the correct handling procedures and precautions for your camera. To ensure the best performance, please read the manual thoroughly before using the camera. Keep the manual handy for quick future reference.

Ricoh Co., Ltd.

Test Shots

Check that your camera is recording the images correctly by taking a number of test shots.

Copyright

Reproduction or alteration of copyrighted documents, magazines, music and other materials, other than for personal, home or similarly limited purposes, without the consent of the copyright holder is prohibited.

Exemption from Liability

Ricoh Co., Ltd. assumes no liability for failure to record or play back images caused by malfunction of the digital camera.

Warranty

This product is manufactured to local specifications and the warranty is valid within the country of purchase. Should the product fail or malfunction while you are abroad, the manufacturer assumes no responsibility for servicing the product locally or bearing the expenditure incurred therefor.

Radio Interference

Operating the digital camera in the vicinity of other electronic equipment may adversely affect the performance of both devices. In particular, operating the camera close to a radio or television may lead to interference. If interference occurs, follow the procedures below.

- Move the camera as far away as possible from the TV, radio or other device
- Reorient the TV or radio antenna.
- Plug the devices into separate electrical outlets.

- This publication may not be reproduced in whole or part without the express written permission of Ricoh. ©2000 Ricoh Co., Ltd. All rights reserved.
- Ricoh reserves the right to change the contents of this publication without notice. Considerable care was taken in preparing this manual. If, however, you have questions about any part of the manual, or note mistakes or inaccuracies, please contact us at the address listed on the back cover.
- The illustrations in this manual may differ from this product. Those are used for the illustration purposes only.

Microsoft, MS and Windows are registered trademarks of Microsoft Corporation in the United States of America and other countries. Macintosh is a registered trademark of Apple Computer, Inc., in the United States of America and other countries. All trademarked company and product names mentioned in this manual are the property of their respective owners.

CONTENTS

Camera Features	4
Parts & Names	5
Explanation of Information Displays	7
LCD Monitor	7
LCD Panel	10
Basic Operation/Quick Reference	11
Preparations	11
Shooting	12
Playback	13
Erasing	14
Safety Precautions	15

Chapter 1 GETTING STARTED

Before Using the Camera	22
Checking the Package Contents	22
Installing the strap and lens cap	22
Powering the Camera	23
Charging the Battery	23
Loading the Battery	24
Using an AC Adapter	26
SmartMedia Memory Cards	27
What is a SmartMedia Memory Card?	27
Inserting a SmartMedia Memory Card	28
How to Use the Mode Dial	30
Menus	31
Setting the Date and Time	34
How to Hold the Camera	36
Adjusting the Camera	38
Diopter Adjustment	38
Adjusting the Brightness of the LCD Monitor	38

Chapter 2 SHOOTING

Basic Shooting	40
Operation Flow	40
Turning on the Camera	41
Selecting a Shooting Mode	41
Selecting a Recording Destination	42
Selecting an Image Quality Mode	43
Setting the Size of the Subject (Zoom)	44
Checking the Position of the Subject	45
Shooting (Still Picture Mode)	46

Special Shooting Functions	49
Text Shooting (Text Mode)	49
Sound Recording (Sound Mode)	50
Continuous Shooting (Continuous Shooting Mode)	50
Motion Picture Shooting (Motion Picture Mode)	51
Still Picture/Text Shooting with Sound	52
Changing Flash Modes	53
Setting the Exposure Compensation	56
Changing the White Balance	57
Using the Self-Timer	59
Close-up Shooting (Macro Mode)	60
Focus Lock Shooting	61
Manual Focus Shooting	62
Red-Eye Reduction Mode	63
Changing the ISO Setting	64
Date Imprinting	64
Soft Mode	65
Monochrome Mode	66
Interval Shooting	67
Auto Bracket Shooting	68
Switching to Non-Compressed Mode	69
Switching to PRO Mode	70
Setting the Time Exposure Mode	72

Chapter 3 PLAYBACK

Before Starting to Playback Recorded Images	74
Files That Can Be Played on the Camera	74
Connecting to a TV	74
Playing Back a File	76
Playing Back a Still Picture/Text/Continuous File	76
Playing a Sound File	77
Playing a Motion Picture File	78
Special Playback Functions	80
Multi Image Playback	80
Zoom Playback	81
Auto Playback	82
Rotating a Displayed File	82
Copying Image Files	83
Playing a File Shot with a Non-Ricoh Camera	84
Protecting a File	85
Setting DPOF (Digital Print Order Format)	86
Setting Printing Services	86

Chapter 4 ERASING

Erasing Files	92
Erase Single Image	92
Erase All Images	93
Erase Selected Images	94

Chapter 5 SETTINGS/MISCELLANEOUS

Transferring Images to a PC	96
Changing Camera Settings	98
Formatting a Card/Internal Memory	98
Keep Settings	99
Changing LCD Confirmation Time	100
Auto Power Off Setting	100
Beep Sound Setting	101
Power Save Mode Setting	101
File Numbering System	102
Changing Video-Out Signal Method (NTSC/PAL)	103
Changing Display Language	103
Initializing Settings	104
Using the Remote Control	105
Shooting	105
Playing	106
Erasing	107

APPENDIX

Accessories	110
Handling Precautions	111
Care and Storage	112
Troubleshooting	113
Using Your Digital Camera in Other Countries	117
About the Warranty and Servicing	118
Specifications	120
Recording Capacities	122

Camera Features

- **3,340,000-pixel resolution compact camera**

With a 3,340,000-pixel resolution CCD, the compact camera produces high quality, high-resolution images (2048 × 1536).

- **Compact camera**

The camera is so light you can carry it with you anywhere.

- **Immediate recording**

Using the camera is as simple as pressing the shutter button. Images thus shot are recorded in the internal memory (8 MB) or on a SmartMedia memory card (2/4/8/16/32/64 MB).

* The internal memory allows you to take pictures without the need for a SmartMedia memory card.

- **Instant playback**

You can instantly review recorded image files simply by switching to Play mode. You can also magnify the images (zoom playback), rotate the LCD monitor, or display several images at once (6-image display).

- **High image quality and multiple image recording modes**

The RDC-7 offers multiple image recording modes to suit your specific photographic needs, including F (Fine) mode which puts the emphasis on image quality, and E (Economy) mode which allows you to capture more images than any other mode.

- **Wide shooting range**

The 3.0X zoom lens allows you to capture subjects in a variety of compositions, from close-ups to shots with a background.

- **Natural colors**

The white balance feature allows you to capture a subject in its natural colors under any lighting conditions, indoors or outdoors.

- **Close-ups**

Macro mode for taking close-up shots at distances up to 1cm (with the lens set on Wide) is ideal for shooting flowers, small objects, etc.

- **Monitors images on the TV screen**

Connect the digital camera to a TV set with the video interface cable supplied and you can display your image files on the TV screen. You can also connect the camera to a video deck or video printer to dub the images onto a videotape or make full color prints.

- **Transfers images to a PC**

You can transfer the images onto a personal computer using software compatible with the digital camera. When loaded onto a PC, the images can be printed on a color printer or color copier.

Parts & Names

■ Camera Body

Front

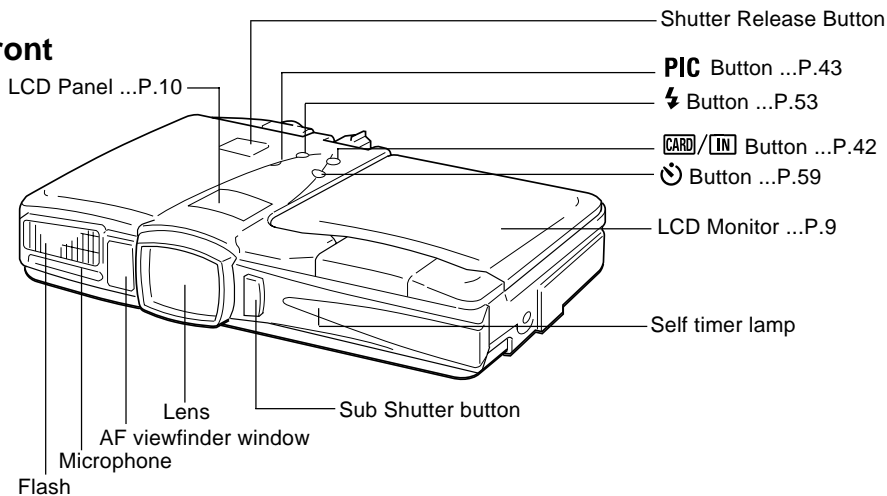

Back

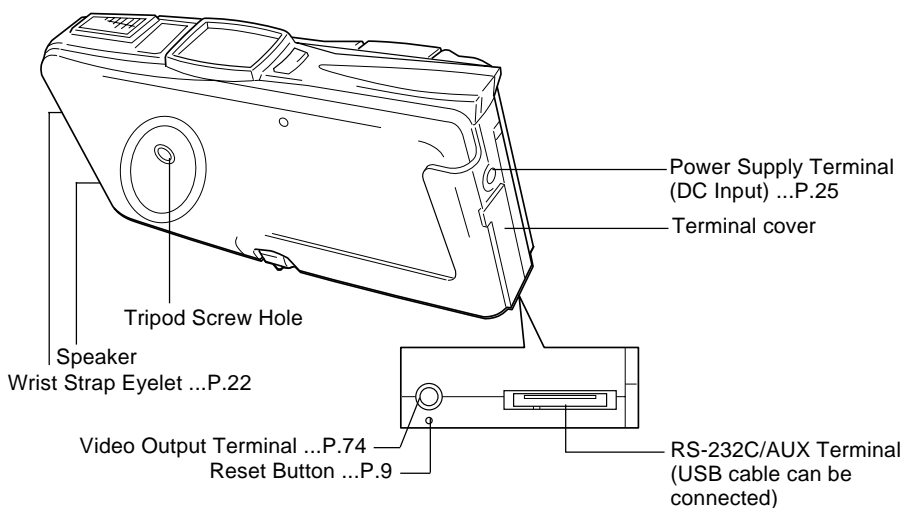

Operation

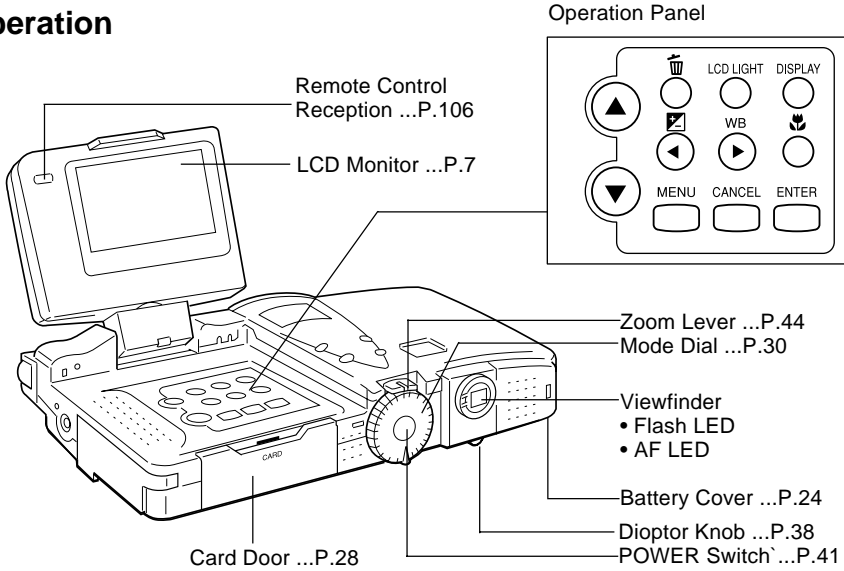

■ Battery

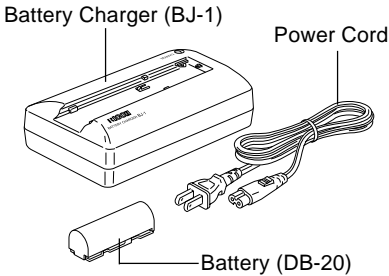

■ AC Adapter (optional)

- AC-3 (120V – 240V)

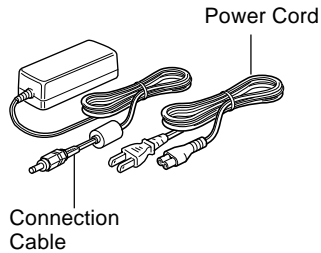

■ SmartMedia Memory Card (optional)

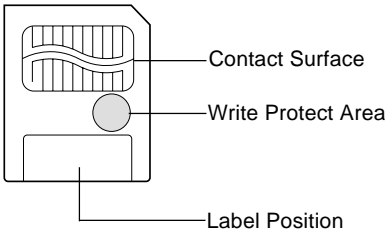

■ Remote Control Unit (optional)

- DR-3

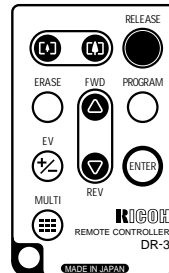

Explanation of Information Displays

The LCD monitor or the LCD panel displays symbols and figures showing the status of your camera, such as the battery level, the number of pictures that can be taken, and the mode settings.

LCD Monitor

Information Displays

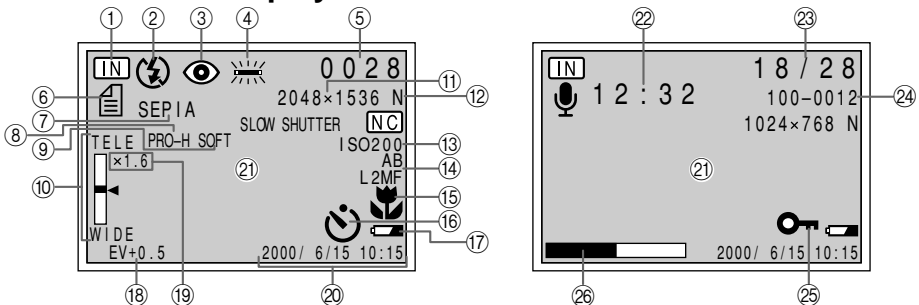

Recording Mode Displays

Play Mode Displays

- ① Recording Destination/Playback Source: • → (p.42, 76)
- ② Flash Mode: • • (blinking) • → (p.53)
- ③ Red-Eye Reduction Mode: → (p.63)
- ④ White Balance Indicator: AUTO • • • → (p.57)
- ⑤ Recording Data Indicator (for recording): Displays the remaining number of pictures or remaining recording time
- ⑥ File Type: Still picture (No Display) • • • → (p.41, 49–53)
- ⑦ Monochrome Indicator: B&W/SEPIA → (p.66)
- ⑧ PRO Mode: PRO, PRO-L, PRO-H → (p.70)
- ⑨ Soft Mode: SOFT → (p.65)
- ⑩ Zoom Indication Bar → (p.44)
- ⑪ Size (No. of pixels): 2048 × 1536 • 1024 × 768 • 640 × 480 → (p.43)
- ⑫ Image Quality (Compression Rate): F • N • E → (p.43)
- ⑬ ISO Sensitivity: ISO200 • ISO400 → (p.64)
- ⑭ Auto Bracket: Manual Focus Mode: MF → (p.60)/
Time exposures (L1, L2, L4, L8) → (p.72)
- ⑮ Macro Mode: → (p.60)
- ⑯ Self-Timer: → (p.59)
- ⑰ Battery Symbol: → (p.8)
- ⑱ Exposure Compensation Level → (p.56)
- ⑲ Digital Zoom → (p.44)
- ⑳ Date & Time Display → (p.34)
- ㉑ Message Display
- ㉒ Sound Recording Time/Motion Picture Recording Time
- ㉓ Recording Data (for playback): Displays the number of the image file being played and total number of files recorded
- ㉔ File Name
- ㉕ Image Protect Mark: → (p.85)
- ㉖ Indicator Display



- All items of information are shown for illustration purposes. During actual camera operation, only the relevant items are displayed.
- File names are used when submitting to digital printing services, etc. If a file that does not conform to the DCF (Design rule for Camera File system) is encountered, [*□□□□□□□□] is displayed. Changing the file name of an image on a personal computer may result in incorrect display on the camera.

■ Warning Messages

If any of the warning messages listed below appears on the camera's LCD monitor, read the corresponding explanation and take the corrective action suggested.

Warning Message	Status	Explanation and Remedy	Reference Page
	Lit	Indicates low battery. Recharge battery.	P. 23
NO CARD	Flashing	A SmartMedia memory card has not been inserted. Mount a SmartMedia memory card.	P. 28
WRITE PROTECTED	Flashing	A write-protected SmartMedia memory card is found. Remove the write-protection label from the card to gain access to it.	P. 27
FILE PROTECTED	Flashing	You attempted to erase a protected file. Unprotect the file before erasing it.	P. 85
NO FILE	Lit	There are no files to play. Mount a SmartMedia memory card with files recorded on it.	P. 28
UNMATCHED FILE	Flashing	You attempted to play an unplayable file.	P. 74
FILE NUMBER OVER	Flashing	No more files can be recorded. Format the internal memory or insert a new SmartMedia memory card to continue recording.	P. 98
SET DATE/TIME	Flashing	The date has not been set. Set the date before starting operations with the camera.	P. 34

■ Error Messages

If any of the error messages listed below appear on the camera's LCD monitor, read the corresponding explanation and take the corrective action suggested.

Error Message	Explanation and Remedy	Reference Page
FORMAT CARD	The SmartMedia memory card is unformatted. Format the card with the camera before using it.	P. 98
FORMAT INTERNAL MEMORY	Format the internal memory before using it.	P. 98
CARD ERROR	A SmartMedia memory card of this type is not supported by this camera. Use a different type of SmartMedia memory card.	—



- If the error display does not clear, reset the LCD monitor to its factory default settings.

How to reset: With the terminal cover open, press the reset button (p.5). If the error display still won't clear, call your dealer or a Ricoh service center.

LCD Panel

Information Displays

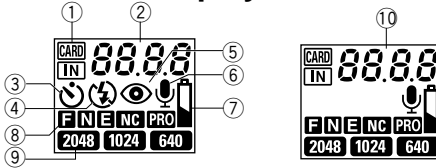

Recording Mode Displays

Play/Erase Mode Displays

- ① Recording Destination/Playback Source: **CARD** • **IN** → (p.42, 76)
- ② Recording Data Indicator (for recording): Displays the remaining number of pictures and remaining recording time
- ③ Self-Timer: → (p.59)
- ④ Flash Mode: AUTO: No display • • • (blinking) → (p.53)
- ⑤ Red-eye Reduction Mode: → (p.63)
- ⑥ Sound Recording Indicator: → (p.50, 52, 77)
- ⑦ Battery Symbol: → (p.8)
- ⑧ Image Quality (Compression Rate): **F** • **N** • **E** • **NC** • **PRO** → (p.43)
- ⑨ Size (No. of Pixels): **2048** • **1024** • **640** → (p.43)
- ⑩ Recording Data Indicator (for playback): Displays the number of the image file being played and playback time

Note • Recording Destination/Playback Source **CARD** • **IN** is displayed for files recorded with another digital camera from the Ricoh DC-3Z/DC-4 or RDC-5000 series or a non-Ricoh camera.

Error Messages

If any of the error messages listed below appear on the camera's LCD monitor, read the corresponding explanation and take the corrective action suggested.

Error Message	Explanation and Remedy	Reference Page
CARD no.f0	The SmartMedia memory card is unformatted. Format the card with the camera before using it.	P. 98
IN no.f0	Format the internal memory before using it.	P.98
CARD Err	A SmartMedia memory card of this type is not supported by this camera. Use a different type of SmartMedia memory card.	—

Note • If the error display does not clear, reset the LCD monitor to its factory default settings.
 How to reset: With the terminal cover open, press the reset button (p.5). If the error display still does not clear, call your dealer or a Ricoh service center.

Basic Operation/Quick Reference

This section provides introductory information for operating the RDC-7 digital camera. Further details can be found in the reference pages mentioned below.

Preparations

Powering the Camera → (p.22-26)

① Load the battery into the camera.

- * When using an AC adapter, connect it to the camera and then to the AC outlet.
→ (p.26)

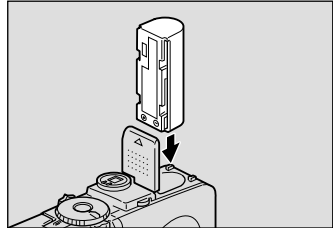
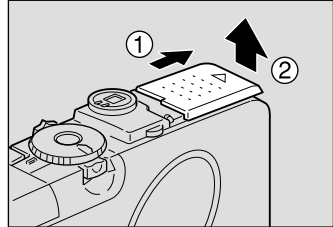

Inserting a SmartMedia Memory Card → (p.27-29)

- ① Make sure that the camera is turned off.**
② Open the card door and insert a SmartMedia memory card.

- * Before using a new SmartMedia memory card, you must first format (initialize) it with the camera. → (p.98)

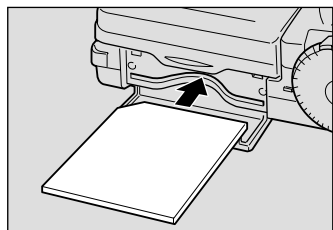
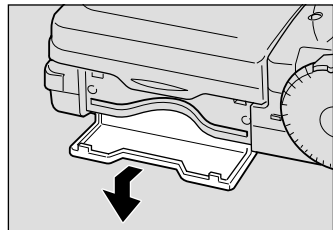

Setting the Date and Time → (p.34-35)

- ❶ Turn the power switch on and set the mode dial to [SET].
- ❷ Press the ▲ or ▼ button to select [DATE SETTING].
- ❸ Press the DISPLAY button to select the display method.
- ❹ Press the ENTER button.
- ❺ Press the ▲ or ▼ button to change the flashing digit.
- ❻ Press the ◀ or ▶ button to select the digit you wish to change.
Repeat steps ❺ and ❻ above to complete the settings.
* Each time you press the ◀ or ▶ button, the flashing digit changes, from year to month, day, hour and minute.
- ❼ After you have set the date and time, press the ENTER button.

SET	◆ 2 / 3
BEEP SOUND	ON
POWER SAVE MODE	OFF
SEQUENTIAL NO.	OFF
DATE SETTING	2000 / 6 / 15
VIDEO OUT MODE	NTSC
SELECT : ▲▼	CHANGE : ◀▶
SEL. : ENTER	

DATE SETTING		
2000 /	6 /	1
SELECT : ▲▼◀▶		
BACK : CANCEL		SEL. : ENTER



Shooting

Basic Shooting Procedure (Still Picture Mode) → (p.41-48)

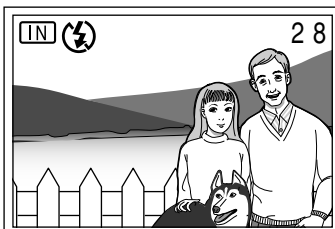
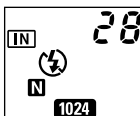
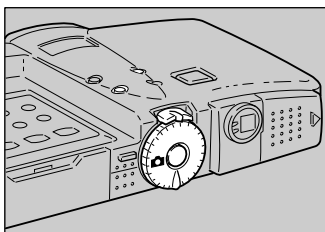



- ❶ Turn the power switch on and set the mode dial to [📷].
- ❷ Press the CARD/IN button to select the recording destination.
- ❸ Press the PIC button to select an image quality mode.
- ❹ Move the zoom lever to select the desired size of the subject.
Move to [▲] to increase the size of the subject and move to [▼] to decrease the size of the subject.
* Check the position of the subject by looking through the viewfinder or at the LCD monitor.
- ❺ Press the shutter release button to record the image.



Changing the Flash Mode → (p.53-55)

① Set the mode dial to [] or [].

② Press the  button to select a flash mode.

You can choose Flash Off (), Auto (), Forced Flash (), or Slow Synchro mode ( blinks).

The mark for the selected mode will be displayed on the LCD monitor or on the LCD panel.

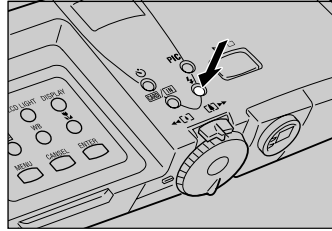
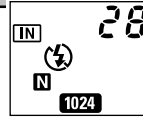

Using the Self-Timer → (p.59)

① Set the mode dial to [] or [].

② Press the  button.

The  mark will be displayed on the LCD monitor or on the LCD panel.

③ Press the shutter release button to record the image.

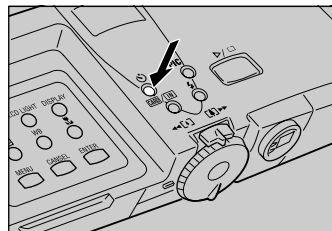
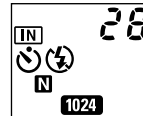

The self-timer LED will start flashing and the shutter will be released after a delay of about 10 seconds.





Playback

Playing Back Files (Still Image Files) → (p.76-78)

① Turn the power switch on and set the mode dial to [].

② Press the  /  button to select the playback source.





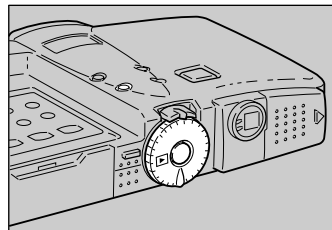

③ Press the  or  button to select a file.

* The zoom playback and multi-image features allow you to magnify an image or view several image files at once. → (p.80, p.82)



Erasing



Erasing Files → (p.92-94)

- 1 Set the mode dial to [].
- 2 Press the  /  button to select the erase source.
- 3 Press the  button.
- 4 Press the  or  button to select the erase mode and press the ENTER button.

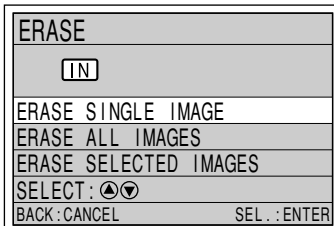
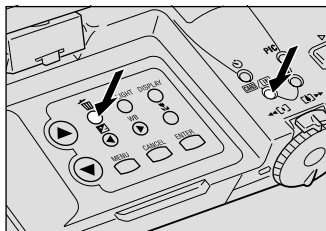
* Remember that files cannot be restored once they are erased. Before starting to erase a file, make sure that you want to erase it.



If you selected [ERASE SINGLE IMAGE]

- 5 Press the  or  button to select a file you want to erase and press the shutter release button.
Repeat step 5 to erase additional images one at a time.

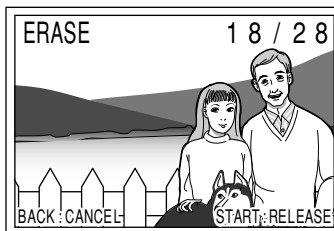



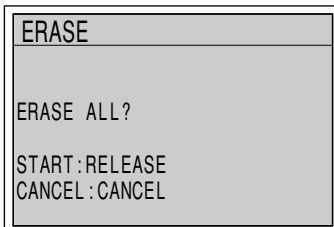

If you selected [ERASE ALL IMAGES]

- 5 Press the shutter release button.



If you selected [ERASE SELECTED IMAGES]

- 5 Press the  or  button and the  or  button to select a file you want to erase and press the ENTER button.
Repeat step 5 to select additional files. To cancel the erase setting, press the ENTER button again.
- 6 Press the shutter release button.

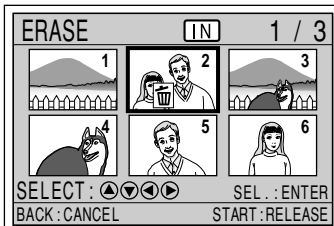

Safety Precautions

Warning Symbols

Various symbols are used throughout this instruction manual and on the product to prevent physical harm to you or other people and damage to property. The symbols and their meanings are explained below.

 **Warning** This symbol indicates matters that may lead to death or serious injury if ignored or incorrectly handled.

 **Caution** This symbol indicates matters that may lead to injury or physical damage if ignored or incorrectly handled.

Sample Warnings



The  symbol alerts you to actions that must be performed.



The  symbol alerts you to prohibited actions.

The  symbol may be combined with other symbols to indicate that a specific action is prohibited.

● Examples



Do not touch



Do not disassemble

Observe the following precautions to ensure safe use of this equipment.

Warning



- Turn off the power immediately in the event of irregularity, such as the equipment emitting smoke or a strange smell. Remove the batteries as soon as possible, being careful to avoid electric shocks or burns. If you are drawing power from a household electrical outlet, be sure to unplug the power cord from the outlet to avoid fire or electrical hazards. Discontinue use of the equipment immediately if it is malfunctioning. Contact the nearest service center at your earliest convenience.

Warning



- Turn off the power immediately if any metallic object, water, liquid or other foreign object gets into the equipment. Remove the batteries as soon as possible, being careful to avoid electric shocks or burns. If you are drawing power from a household electrical outlet, be sure to unplug the power cord from the outlet to avoid fire or electrical hazards. Discontinue use of the equipment immediately if it is malfunctioning. Contact the nearest service center at your earliest convenience.



- Avoid any contact with the liquid crystal inside the LCD monitor, should the monitor be damaged. Follow the emergency measures below in the following circumstances.
 - **SKIN:** If any of the liquid crystal gets on your skin, wipe it off and rinse the affected area thoroughly with water, then wash well with soap.
 - **EYES:** If it gets in your eyes, wash your eyes with clean water for at least 15 minutes and seek medical advice immediately.
 - **INGESTION:** If any of the liquid crystal is ingested, rinse the mouth out thoroughly with water. Have the victim drink a large amount of water and induce vomiting. Seek medical assistance immediately.

Warning



- Keep the battery used in this equipment out of the reach of children to prevent accidental ingestion of harmful substances. Consumption of battery fluid is extremely harmful to human beings. If swallowed, seek immediate medical assistance.



- Keep the equipment out of the reach of children. Their inability to read and understand warnings and safety precautions may lead to accidents.



- Do not touch the internal components of the equipment if they become exposed as a result of being dropped or damaged. The high-voltage circuitry in the equipment could lead to an electric shock. Remove the batteries as soon as possible, being careful to avoid electric shocks or burns. Take the equipment to your nearest dealer or service center if it is damaged.



- Do not attempt to disassemble, repair or alter the equipment yourself. The high-voltage circuitry in the equipment poses significant electrical hazard.



- Do not use the equipment in the bathroom or shower as this could result in fire or electric shock.

Warning



- Do not use the equipment near flammable gases, gasoline, benzine, thinner or similar substances to avoid the risk of explosion, fire or burns.
- Do not use the equipment in aircraft or other locations where usage is restricted or prohibited as this may lead to disasters or accidents.



- Wipe off any dust that accumulates on the electrical plug as this may lead to fire.
- Use only the specified AC adapters for this equipment (optional AC-3) in household electrical outlets. Other adapters pose the risk of fire, electric shock or injury.



- To avoid the risk of fire, electric shock or injury, do not use the AC adapter with commercially available electronic transformers when traveling abroad.

Observe the following precautions to ensure safe use of this unit.

Caution



- Contact with fluid leaking from a battery can lead to burns. If part of your body comes in contact with a damaged battery, wash the area with water immediately. (Do not use soap.) If a battery starts to leak, remove it immediately from the equipment and wipe the battery chamber thoroughly before replacing it with a new battery.



- Plug the power cords securely into the electrical outlets. Loose cords pose a fire hazard.



- Do not allow the camera to get wet. In addition, do not operate it with wet hands. Both pose the risk of electric shock.



- Do not fire the flash at drivers of vehicles, such as bicycles, cars and trains, as this may cause the driver to lose control and result in a traffic accident.

Safety Warnings for Accessories

- Safety warnings for the optional accessories, such as the AC adapter, are contained in the instruction manual provided with each product and should be read thoroughly before operating the equipment.

GETTING STARTED Chapter

1

Before Using the Camera	22
Checking the Package Contents	22
Installing the strap and lens cap	22
Powering the Camera	23
Charging the Battery	23
Loading the Battery	24
Using an AC Adapter	26
SmartMedia Memory Cards	27
What is a SmartMedia Memory Card?	27
Inserting a SmartMedia Memory Card	28
How to Use the Mode Dial	30
Menus	31
Setting the Date and Time	34
How to Hold the Camera	36
Adjusting the Camera	38
Diopter Adjustment	38
Adjusting the Brightness of the LCD Monitor	38

Before Using the Camera

Checking the Package Contents

Check that your digital camera comes complete with all the accessories listed below. Read the warranty card and keep it in a safe place.

- Digital camera 1
- Lens cap 1
- AV interface cable 1
- Soft case 1
- Battery (Lithium ion battery) 1
- Battery charger 1
- Wrist strap 1
- Operation manual (this manual) 1
- Warranty card/Registration card 1
- PC Connection cable (RS-232C) 1
- Macintosh Cable (AUX) 1
- USB Cable 1
- Software CD-ROM 1

Installing the strap and lens cap

Attach the wrist strap and the lens cap.

Pass the small loop of the strap through the wrist strap eyelet and pass the other end through the loop as illustrated.



- Do not swing the camera around by its strap.

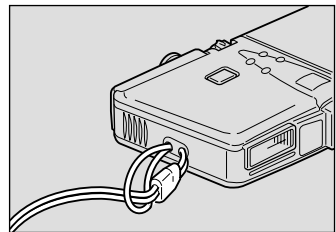

Attach the lens cap by pressing the buttons in the direction of the arrow.
Remove the lens cap by gripping and pressing.

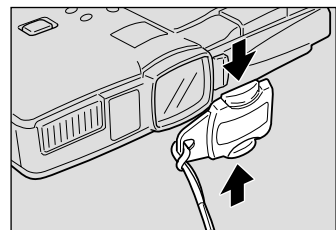

Powering the Camera

This section explains how to load and charge the battery, and how to connect the AC adapter to power the camera from a household electrical outlet.

Charging the Battery

When using the camera for the first time or when the battery symbol (🔋) lights, charge the battery to its full capacity following the procedure described below.

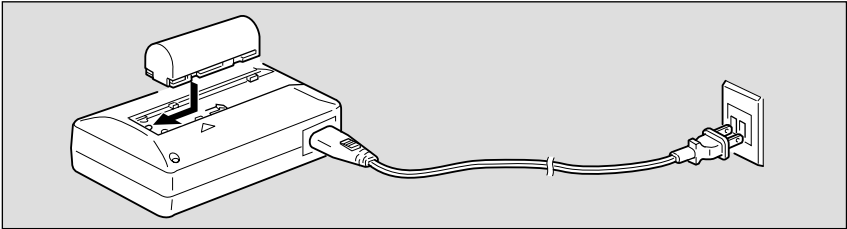

1 Set the battery on the battery charger.

2 Insert the plug into an electrical outlet.

Charging will start and continue as shown below. When charging is completed, disconnect the power plug from the power outlet.

Charge lamp	Contents
Lights red	Charging has started.
Lights green	The completion of charging (90% of full charge), after approximately 60 min.
Lamp off	Full charge has been reached, approximately 40 min. after the lamp lights green.

■ Precautions

- Do not use the batteries other than the Ricoh DB-20.
- Use only a Ricoh BJ-1 battery charger to charge the battery.
- Do not use the BJ-1 battery charger to charge batteries other than the DB-20 battery.
- Charge the battery in a well ventilated area with an ambient temperature of 10°C – 40°C (50°F – 104°F).
- When the battery reaches the end of its service life, even if charged correctly, it will be effective for shorter and shorter periods. Replace with a new battery.
- After charging, the battery will feel hot, but this is normal.
- After charging, remove the power plug from the electrical outlet. Failure to do so may result in fire.

Loading the Battery

Load the battery (rechargeable lithium ion battery) before operating the camera.



- Before using the camera for the first time, be sure to charge the battery. (The battery leaves the factory in an uncharged state.) See [Charging the Battery] → p.23.

- 1 Check that the camera is turned off, and then open the battery cover by pressing and sliding it in the direction shown.

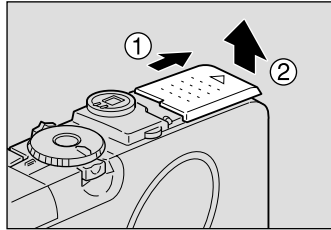

- “Turning on the Camera” (p.41).

- 2 Load the battery.



- Do not bring metallic objects, such as a needle, into contact with the battery contact surface or electrical connections. Electrostatic damage could result.

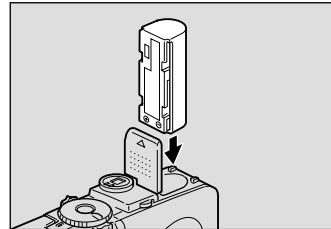

- 3 Close the battery cover.

Close the battery cover until it clicks into position.

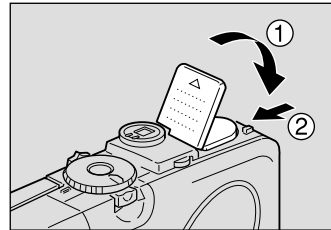

● Shooting and Playback Guidelines

The table below shows the approximate recording and playback times, as measured under the following test conditions:

[Test conditions]

During shooting: Shoot continuously in recording mode with the power turned on (shoot at intervals of 30 seconds, without turning the camera off in the middle, with the flash fired 50%, at a temperature of 20°C)

During playback: Leave the camera continuously turned on in playback mode at a temperature of 20°C

Battery Type	Approximate Recording Time	Approximate Playback Time
Lithium ion battery (fully charged)	50 minutes	50 minutes

Tips to Extend Recording and Playback Times

- * The battery life indicated on the previous page tends to decrease depending on the ambient temperature.
In a cold environment, warming the battery by hand, for example, may allow you to take more pictures.
- * Increased use of the flash or zoom feature or the LCD monitor will accelerate expiration of the battery. Keep their usage to a minimum.
- * Copying or erasing images repeatedly will also accelerate expiration of the battery.
- * The battery life may be extended by shooting images without using the LCD monitor.

■ Handling Precautions

- Read the instruction manual supplied with the battery before using it.
- Use only the specified lithium ion battery. Check the type of battery in “Accessories” (p.110).
- Cleaning the contact area of the battery terminal and the battery with a dry cloth may extend the life of the battery.
- Do not use a battery with a low voltage (such as one which has already caused the battery symbol (⚡) to flash) as this may cause malfunction of the camera (malfunction of the LCD monitor or flashing or lighting of the AF LED, flash LED or self-timer LED).
- If the camera is used continuously for a long period, the battery may become hot. Allow to cool before unloading it.
- Except when charging the battery, store the charger and the battery separately.
- Store the battery in the case provided.
- If the camera is not to be used for a long period, discharge the battery completely before removing it from the camera and store in a cool place. Recharge the battery fully before reusing the camera.

- Note**
- When using the camera for an extended period near an electrical source, it is recommended to use an AC adapter (optional). See “Using an AC Adapter” (p.26).
 - It is advisable to have a spare battery handy when powering the camera by the battery alone.
 - The battery symbol (⚡) lights to show that the battery voltage is low. Recharge the battery. See “Charging the Battery” (p.23).

Using an AC Adapter

When using the camera for long periods of time to record or playback images, connect an AC adapter (optional) to the camera and power the camera from a household electrical source.

Using the AD Adapter

Before using the AC adapter, be sure to read the safety precautions in the accompanying manual.

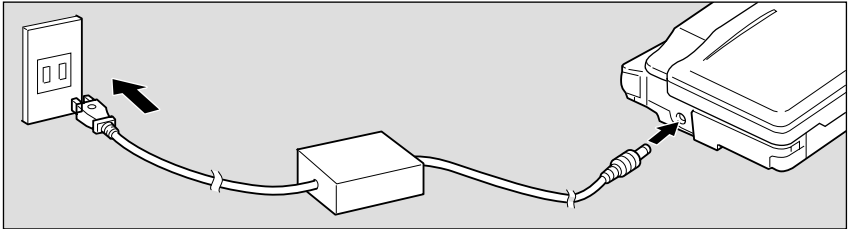

- 1 Check that the camera is turned off. Connect the AC adapter cable to the power supply terminal (DC input) on the camera.

See • “Turning on the Camera” (p.41).

- 2 Insert the power plug into the electrical outlet.

Note • If the battery is loaded in the camera while it is connected to the household power source, the camera is powered from the AC source and not by the battery.

- Unload the battery when using the camera for long periods of time.

Important Note

- Insert the power plug and connection cable securely. If the plug or cable works loose during recording, the data may be lost or damaged.
- If you connect or disconnect the AC adapter while operating the camera (recording, playback, or erasing), the camera will switch off to determine the power source. This may cause the data to be lost or damaged. To avoid this, connect or disconnect the AC adapter while the camera is turned off.

SmartMedia Memory Cards

This section explains the types and usage of SmartMedia memory cards.

What is a SmartMedia Memory Card?

Files are recorded as data on the SmartMedia memory card in your camera. The following types of SmartMedia memory cards can be used:

- Capacity: 2 MB, 4 MB, 8 MB, 16 MB, 32 MB, 64 MB
- Operating voltage: 3.3 V

- Note**
- There are numerous types of SmartMedia memory cards. Before using a commercially available SmartMedia memory card, check with the manufacturer that it is compatible with your camera.
 - By using an optional PC card adapter or floppy disk adapter, you can insert a SmartMedia memory card directly into the PC card slot or floppy disk drive of your PC.

■ Protecting Against Accidental Writing

Attaching a write protect pad to a SmartMedia memory card will prevent accidental erasure or overwriting of recorded files.

Remove the write protect pad from the SmartMedia memory card to record or erase data.

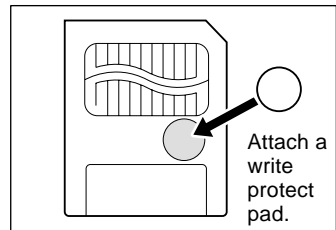

- Note**
- If the write protect pad gets dirty, wipe it clean with a soft, dry cloth.

■ Handling Precautions

● SmartMedia Memory Cards

- Never remove the SmartMedia memory card while data is being recorded or erased.
- Do not bend, subject to strong force or shock, or drop the SmartMedia memory card.
- Avoid using or storing SmartMedia memory cards in environments that are subject to static electricity or electrical interference.
- Avoid using or storing SmartMedia memory cards in environments that are subject to high temperature and humidity, where dust accumulates, or in atmospheres where corrosive substances are present.

- Keep the contact surface of the SmartMedia memory card clean and free from dust and foreign matter. Should the contact surface get dirty, wipe it clean with a soft, dry cloth.
- Keep the SmartMedia memory card slot free from dust and foreign matter.
- To avoid possible hazards, keep SmartMedia memory cards away from flames and do not dispose of them in fire.
- SmartMedia memory cards have a limited service life. Cards that have been used over an extended period of time may fail to record additional files.

● Data

- Data recorded on a SmartMedia memory card may be lost by improper handling by the customer or a third party, by being subjected to static electricity or electrical interference, or during camera malfunction or repair. Ricoh Co., Ltd. assumes no liability for damages incurred by such loss of recorded data.
- Do not remove the battery from the camera, turn off the camera, or connect the AC adapter while data is being recorded on the SmartMedia memory card. The data stored on the SmartMedia memory card may be lost or damaged.
- You are advised to copy important data from the SmartMedia memory card onto other media, such as floppy disks or hard disks.

Inserting a SmartMedia Memory Card

Check that the camera is turned off before inserting the SmartMedia memory card.



- Never insert or remove a SmartMedia memory card while the camera is turned on. The data stored on the SmartMedia memory card may be lost or damaged, or the camera may malfunction.
- When using a new SmartMedia memory card, or when using a SmartMedia memory card that has been used on other equipment, such as a personal computer, the SmartMedia memory card must first be formatted (initialized) with the camera. See "Formatting a Card/Internal Memory" → (p.98).

■ Inserting Card

- ① Check that the camera is turned off, and then open the card door.



- "Turning on the Camera" (p.41).

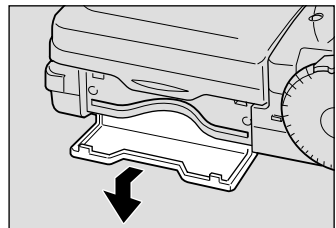

- 2 **Insert the SmartMedia memory card into the card insert slot and close the card door.**

Push the SmartMedia memory card fully into position, with the contact surface facing down.

Set with the contact surface facing down

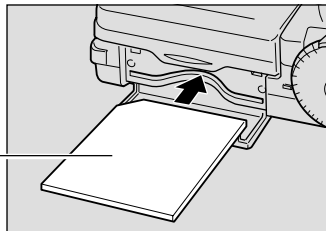

- Note**
- Insert the SmartMedia memory card in the correct direction. Do not insert it at an angle.
 - The camera will not turn on when the card door is open.

■ Removing Card

- 1 **Check that the camera is turned off, and then open the card door.**

See • “Turning on the Camera” (p.41).

- 2 **Pull the SmartMedia memory card straight out of the slot.**

- 3 **Close the card door.**

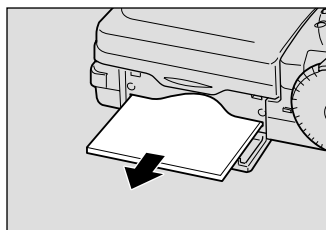
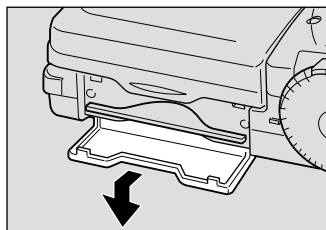







Important Note

- Never remove the SmartMedia memory card while data is being recorded or erased. The data stored on the card may be lost or damaged.
- When the SmartMedia memory card has been removed, place it in the antistatic case supplied or other protective cover.







How to Use the Mode Dial

The camera offers a number of recording and playback modes. Select the desired mode with the mode dial.

-  Still picture mode : This mode is used for normal shooting.
-  Sound mode : This mode is used for recording sound.
-  Text mode : This mode is used for recording text.
Recording is in two colors, black and white, without any gradations.
-  Continuous shooting mode : In this mode, the subject is shot continuously while the shutter button is depressed.
-  Motion picture mode : This mode is used for recording motion pictures with sound.
-  Play mode : This mode is used for playing recorded image files.
- SET Settings mode : This mode is used for entering or changing the camera settings.

1 Turn the mode dial to select the desired mode.

The information displayed on the LCD monitor varies depending on the mode. For details, see the reference pages listed below.

-  (still picture) → p.41
-  (sound) → p.50
-  (text) → p.49
-  (continuous shooting) → p.50
-  (motion picture) → p.51
-  (play) → p.76
- SET (settings) → p.98

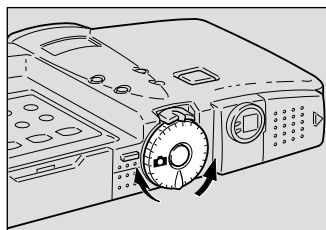

Menus

This camera features various menus which can be used to enter or change the settings. Select and set the items using the buttons on the operation panel as shown below.





■ Menu Displays

● SET Menu

Set the mode dial to setting mode (SET).
To exit the set menu, turn the mode dial to select another mode.

SET	▼ 1 / 3
FORMAT	➡
SERIAL TRANSFER	➡
KEEP SETTINGS	➡
LCD CONFIRMATION	1SEC.
AUTO POWER OFF	1MIN
SELECT: ▲▼	CHANGE: ◀▶
SEL.: ENTER	

● SHOTTING Menu

Set the mode dial to shooting mode
( •  •  •  • ) and press the MENU button.
To exit the record menu, press the MENU button again.



SHOOTING MODE	▼ 1 / 3
IMAGE WITH SOUND	OFF
FOCUS	AF
FLASH STRENGTH	NORMAL
REDEYE REDUCTION	OFF
ISO SENSITIVITY	AUTO
SELECT: ▲▼	CHANGE: ◀▶
BACK: MENU	SEL.: ENTER

● PLAYBACK Menu

Set the mode dial to play mode () and press the MENU button.
To exit the playback MENU, press the MENU button again.

PLAYBACK MODE	▼ 1 / 2
MULTI IMAGE	➡
ZOOM PLAYBACK	➡
AUTO PLAYBACK	1SEC.
COPY	➡
SELECT FOLDER	➡
SELECT: ▲▼	CHANGE: ◀▶
BACK: MENU	SEL.: ENTER

● ERASE Menu

Set the mode dial to play mode () and press the  button.
To exit the erase menu and return to play mode, press the  button again.

ERASE	
	
ERASE SINGLE IMAGE	
ERASE ALL IMAGES	
ERASE SELECTED IMAGES	
SELECT: ▲▼	
BACK: CANCEL	SEL.: ENTER

 • For details of the settings that can be made on each menu, see “Menu Settings” (p.32).

■ Selecting, Setting and Cancelling Items

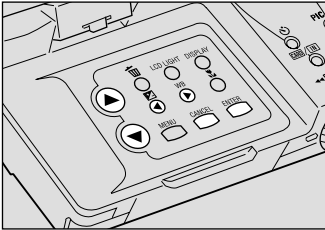

- ENTER button : Enters the setting. Enters the selected setting at the position indicated by the arrow (➔) and proceeds to the next display.
- CANCEL button : Cancels the setting and returns to the previous display.
- ◀ or ▶ button : Changes the setting.
- ▲ or ▼ button : Selects the setting you want to change.

■ Menu Settings

● SET Menu

SET	▼ 1 / 3
FORMAT	➔
SERIAL TRANSFER	➔
KEEP SETTINGS	➔
LCD CONFIRMATION	1SEC.
AUTO POWER OFF	1MIN
SELECT: ▲▼	CHANGE: ◀▶
SEL.: ENTER	

- FORMAT : Formats the internal memory or SmartMedia memory card. → (p.98)
- SERIAL TRANSFER : Used to transfer recorded files to a personal computer.
- KEEP SETTINGS : Saves the camera settings. → (p.99)
- LCD CONFIRMATION : Sets the confirmation time for images after shooting. → (p.100)
- AUTO POWER OFF : Enables or disables the automatic power off feature. → (p.100)

SET	◆ 2 / 3
BEEP SOUND	ON
POWER SAVE MODE	OFF
SEQUENTIAL NO.	OFF
DATE SETTING	2000 / 6 / 15
VIDEO OUT MODE	NTSC
SELECT: ▲▼	CHANGE: ◀▶
SEL.: ENTER	

- BEEP SOUND : Switches the beep sound on and off. → (p.101)
- POWER SAVE MODE : Decreases the brightness of the LCD monitor to conserve battery power. → (p.101)
- SEQUENTIAL NO. : Switches consecutive numbering of files on and off. → (p.102)
- DATE SETTING : Sets the date and time. → (p.34)
- VIDEO OUT MODE : Switches between NTSC and PAL when the camera is connected to a TV set. → (p.103)

SET	▲ 3 / 3
LANGUAGE	ENGLISH
INITIALIZE SETTING	➔
SELECT: ▲▼	CHANGE: ◀▶
SEL.: ENTER	

- LANGUAGE : Selects the language of the LCD monitor display. → (p.103)
- INITIALIZE SETTING : Returns all the settings to their initial status. → (p.104)

Note • [SERIAL TRANSFER] is used to transfer recorded files to a personal computer by serial connection.

● Record Menu

SHOOTING MODE	▼ 1 / 3
IMAGE WITH SOUND	OFF
FOCUS	AF
FLASH STRENGTH	NORMAL
REDEYE REDUCTION	OFF
ISO SENSITIVITY	AUTO
SELECT: ▲▼	CHANGE: ●◎
BACK: MENU	SEL.: ENTER

- IMAGE WITH SOUND : Records with sound in (still picture) and (text) modes. → (p.52)
- FOCUS : Switches between auto focus and manual focus. → (p.62)
- FLASH STRENGTH : Selects the level of strength of the flash. → (p.55)
- REDEYE REDUCTION : Lessens the red-eye phenomenon when using the flash. → (p.63)
- ISO SENSITIVITY : Selects the ISO setting. → (p.64)

SHOOTING MODE	◆ 2 / 3
DATE IMPRINT	OFF
SOFT MODE	OFF
MONOCHROME MODE	OFF
INTERVAL MODE	→
AUTO BRACKET	OFF
SELECT: ▲▼	CHANGE: ●◎
BACK: MENU	SEL.: ENTER

- DATE IMPRINT : Records images with the date imprinted. → (p.64)
- SOFT MODE : Records images with a soft outline. → (p.65)
- MONOCHROME MODE : Records images in monochrome or sepia. → (p.66)
- INTERVAL MODE : Selects interval shooting. → (p.67)
- AUTO BRACKET : Records three images at -0.5 EV, 0 and +0.5 EV based on the current exposure compensation level. → (p.68)

SHOOTING MODE	▲ 3 / 3
NO COMPRESSION	OFF
PRO	OFF
TIME EXPOSURE	OFF
SELECT: ▲▼	CHANGE: ●◎
BACK: MENU	SEL.: ENTER

- NO COMPRESSION : Records in non-compressed mode. → (p.69)
- PRO : Records in PRO mode. → (p.70)
- TIME EXPOSURE : Set when photographing a bright subject in a dark place with (still image) set. → (p.72)

● Play Menu

PLAYBACK MODE	▼ 1 / 2
MULTI IMAGE	→
ZOOM PLAYBACK	→
AUTO PLAYBACK	1SEC.
COPY	→
SELECT FOLDER	→
SELECT: ▲▼	CHANGE: ●◎
BACK: MENU	SEL.: ENTER

- MULTI IMAGE : Displays 6 files at once. → (p.77)
- ZOOM PLAYBACK : Displays an enlarged file. → (p.81)
- AUTO PLAYBACK : Automatically plays all files. → (p.82)
- COPY : Copies recorded files from the internal memory onto a SmartMedia memory card, and vice versa. → (p.83)
- SELECT FOLDER : Plays files shot with another (Ricoh or non-Ricoh) digital camera. → (p.84)

PLAYBACK MODE	▲ 2 / 2
ROTATION	OFF
PROTECT	→
DPOF	→
SELECT: ▲▼	CHANGE: ●◎
BACK: MENU	SEL.: ENTER

- ROTATION : Turns a file 90 degrees right, 90 degrees left, or 180 degrees. → (p.82)
- PROTECT : Protects files from erasure. → (p.85)
- DPOF : Sets the number of copies, etc. when submitting recorded files to digital printing services. → (p.86)

● Erase Menu

ERASE	
[IN]	
ERASE SINGLE IMAGE	
ERASE ALL IMAGES	
ERASE SELECTED IMAGES	
SELECT: ▲▼	
BACK: CANCEL	SEL.: ENTER

- ERASE SINGLE IMAGE : Erases selected images one at a time. → (p.92)
- ERASE ALL IMAGES : Erases all the recorded files. → (p.93)
- ERASE SELECTED IMAGES : Erases multiple selected images. → (p.94)

* Protected files cannot be erased.

Setting the Date and Time

The set date and time are recorded when you shoot a picture. You will need to adjust these settings when you first use the camera and each time you change time zones on trips.

- Note**
- Use the yyyy/mm/dd format to set the date.
 - Time is displayed in the 24-hour clock format. Midnight is expressed as 00:00 and noon as 12:00.

- 1 Press the power switch to turn the camera on and set the mode dial to [SET].**

See "Turning on the Camera" (p.41).

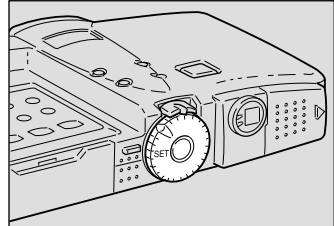

- 2 Press the \blacktriangle or \blacktriangledown button to select [DATE SETTING].**

SET	◆ 2 / 3
BEEP SOUND	ON
POWER SAVE MODE	OFF
SEQUENTIAL NO.	OFF
DATE SETTING	2000 / 6 / 15
VIDEO OUT MODE	NTSC
SELECT : \blacktriangle \blacktriangledown	CHANGE : \blacktriangle \blacktriangleright
SEL. : ENTER	

- 3 Press the DISPLAY button to select the date display method.**

There are three ways of displaying the date:
2000/5/15 → May 15 2000 → 15 May 2000
Each time you press the DISPLAY button, the display method is switched in the sequence shown above. Press the DISPLAY button to select the desired date display method.

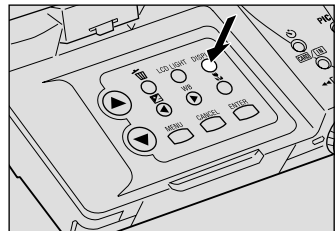

- 4 Press the ENTER button.**

The date setting menu is displayed.

- 5 Press the \blacktriangle or \blacktriangledown button to change the flashing digit.**

Press the \blacktriangle button to increase the digit and the \blacktriangledown button to decrease the digit. Pressing the button continuously increases the speed.

DATE SETTING		
2000 /	1 /	1
SELECT : \blacktriangle \blacktriangledown \blacktriangleright \blacktriangleleft		
BACK : CANCEL	SEL. : ENTER	

6 Press the ◀ or ▶ button to highlight the digit you wish to change.

Make the required changes by repeating steps 5 and 6.

Note Each time the ▶ button is pressed, the highlighted digit changes in the sequence: year → month → day → hour → minute.

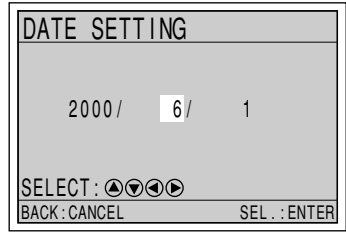

7 After setting the minutes, press the ENTER button.

The clock will start and the display will return to the SET menu.

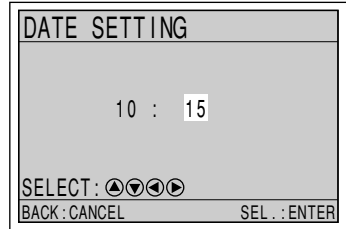

- Note**
- The accurate time can be set by pressing the ENTER button at the same time as a time broadcasting signal.
 - The set date and time will be reset about 1 month after the battery has been removed, for example when changing the battery. In this case, reset the date and time.

Tips How to check the date and time
Press the DISPLAY button to display the set date and time on the LCD monitor. See "LCD Monitor Display Function" → (p.48).

How to Hold the Camera

Unintentional movement of the camera during shooting will result in blurred images. To avoid such so-called “camera shake”, hold the camera as described below. Be particularly careful to avoid camera shake with telephoto zoom shots.

① Hold the camera steady with both hands with your elbows close to your body.

● When viewing through the viewfinder

With the camera pressed lightly to your face, aim it at your subject while looking through the viewfinder.

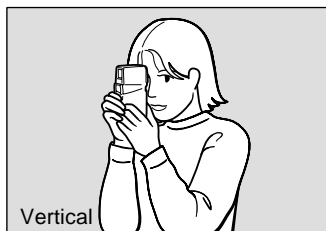

● When viewing on the LCD monitor

Hold the camera firmly in both hands, and aim it at your subject while looking at the LCD monitor.

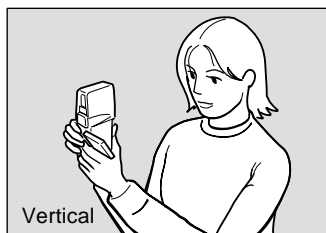

② Press the shutter release button lightly with your fingertip.

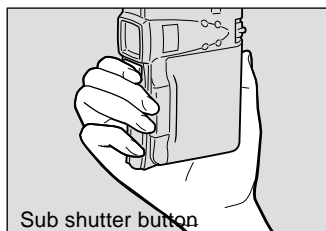
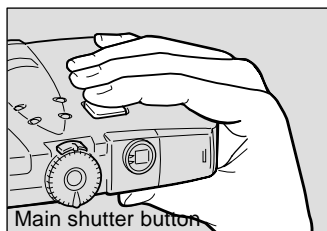



- Keeping your finger away from the shutter button and then pressing the shutter button in one go may result in a blurred image.
- Do not move the camera until the beep sound is heard.

You can turn the LCD monitor as shown in the diagram, allowing you to shoot at any angle you wish.



- The LCD monitor can only be turned when it is open at an angle of 90°.

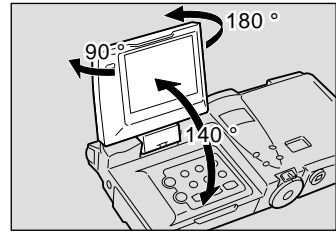

■ Usage Precautions

Be careful to keep the camera lens, flash, and flash sensor reception window from being covered by your fingers or hair, or by the wrist strap.

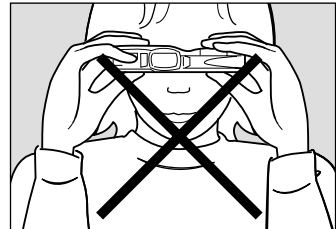

Adjusting the Camera

Adjust the brightness of the LCD monitor and the diopter.

Diopter Adjustment

Adjust the diopter so that the subject is clearly visible through the viewfinder.

Adjust by rotating the diopter knob left or right until the subject appears clearly.

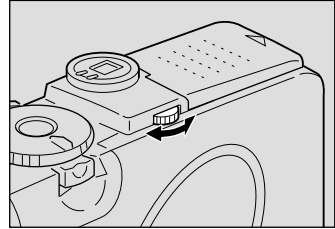

Adjusting the Brightness of the LCD Monitor

You can adjust the brightness of the LCD monitor when it is hard to see.

① Press the LCD LIGHT button on the operation panel.

Each time you press the button, the brightness changes. The brightness can be adjusted in five stages.

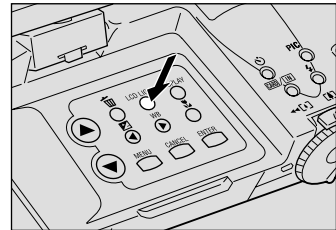

SHOOTING Chapter

2

Basic Shooting	40
Operation Flow	40
Turning on the Camera	41
Selecting a Shooting Mode	41
Selecting the Recording Destination	42
Selecting an Image Quality Mode	43
Setting the Size of the Subject (Zoom)	44
Checking the Position of the Subject	45
Shooting (Still Picture Mode)	46
Special Shooting Functions	49
Text Shooting (Text Mode)	49
Sound Recording (Sound Mode)	50
Continuous Shooting (Continuous Shooting Mode)	50
Motion Picture Shooting (Motion Picture Mode)	51
Still Picture/Text Shooting with Sound	52
Changing Flash Modes	53
Setting the Exposure Compensation	56
Changing the White Balance	57
Using the Self-Timer	59
Close-up Shooting (Macro Mode)	60
Focus Lock Shooting	61
Manual Focus Shooting	62
Red-Eye Reduction Mode	63
Changing the ISO Setting	64
Date Imprinting Mode	64
Soft Mode	65
Monochrome Mode	66
Interval Shooting Mode	67
Auto Bracket Shooting	68
Switching to Non-Compressed Mode	69
Switching to PRO Mode	70
Setting the Time Exposure Mode	72

Basic Shooting

This section explains the general operation flow and basic shooting instructions.

Operation Flow

To record an image, follow the steps below.

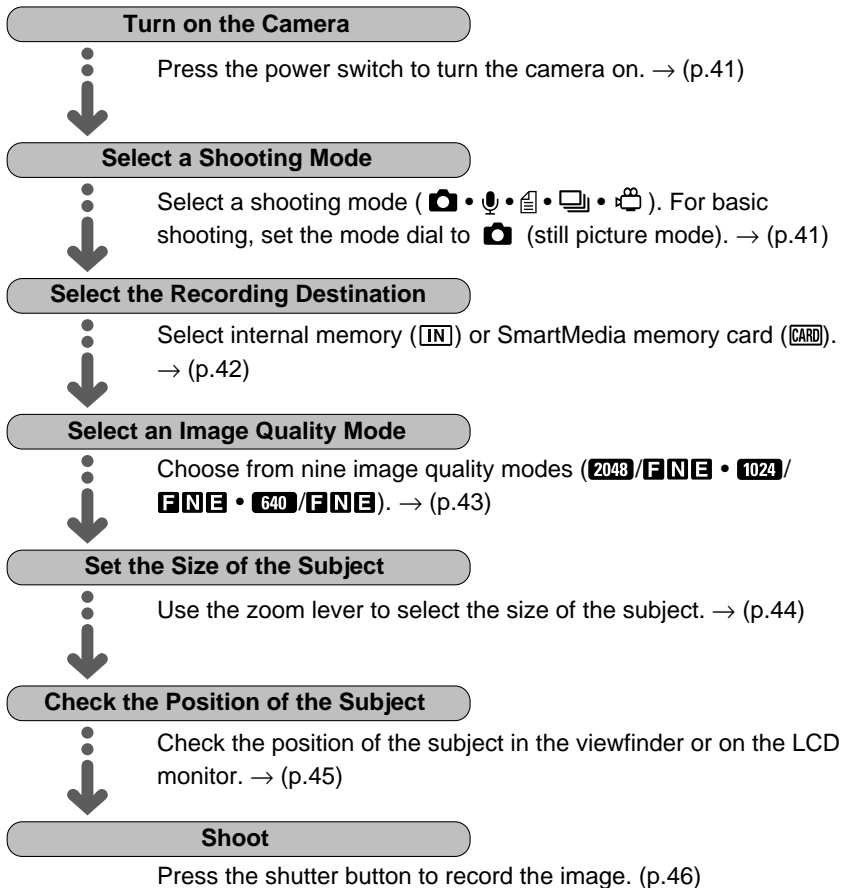

Turning on the Camera

The camera is turned on and off by means of the power switch.

① Open the LCD monitor and press the power switch.

The camera will turn on.

To turn the camera off, press the power switch again.

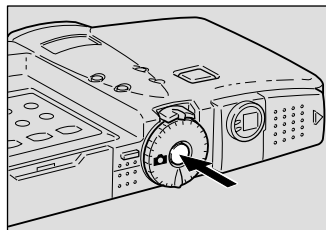

Tips





Auto Power Off

The camera will turn off automatically (auto power off) to conserve the battery if it is left idle (no buttons or switches operated) for a preset time. To resume use, turn the power on again.

The auto power off feature does not function when the camera is powered by an AC adapter.

See “Auto Power Off Setting” → (p.100).

Selecting a Shooting Mode

The camera offers five shooting modes ( •  •  •  • ). Select the mode best suited to your photographic needs.

The explanation below is based on  (still picture mode).

① Set the mode dial to [].

See • “How to Use the Mode Dial” (p.30).

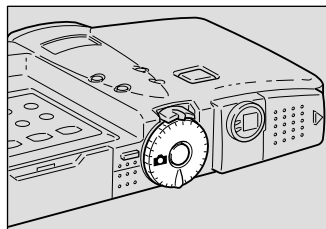

The recording data will be displayed on the LCD panel or on the LCD monitor.

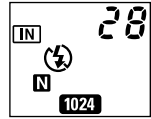

● LCD Monitor Display

When the LCD monitor is open, the display appears, and when the LCD monitor is closed, the display is cleared.

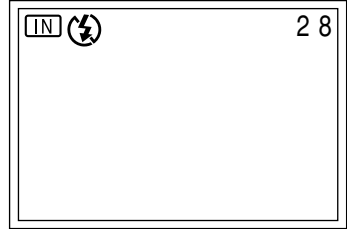

- Note** • If the LCD monitor is difficult to see, for example in bright sunlight, press the LCD LIGHT button to adjust the brightness. See “Adjusting the Brightness of the LCD Monitor” → (p.38).

Selecting a Recording Destination

Select whether to record shot files in the internal memory or on the SmartMedia memory card mounted in the camera.

- **IN** : Records in the internal memory
- **CARD** : Records on the SmartMedia memory card

① Press the **CARD/IN** button and select the recording destination (**CARD** • **IN**).

The recording destination changes each time the **CARD/IN** button is pressed.

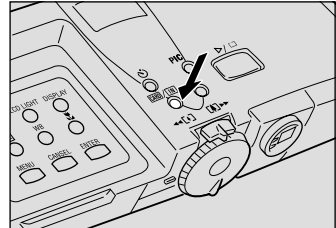

The selected recording destination will be displayed.

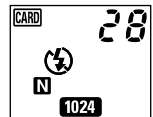

- Note** • If a SmartMedia memory card is mounted in the camera when it is turned on, the **CARD** mark will be displayed. To set the internal memory as the recording destination, enable the keep settings mode. See “Keep Settings” → (p.99).

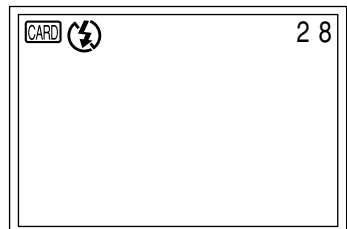

Selecting an Image Quality Mode

The camera offers nine image quality modes. Select the mode best suited to your photographic needs.

- **2048 / F N E** : 2048 × 1536 (F), 2048 × 1536 (N), 2048 × 1536 (E)
- **1024 / F N E** : 1024 × 768 (F), 1024 × 768 (N), 1024 × 768 (E)
- **640 / F N E** : 640 × 480 (F), 640 × 480 (N), 640 × 480 (E)
- The recordable picture count varies as you switch the image quality mode.
- The factory default setting is **1024 N**.

1 Press the PIC button and select an image quality mode.

The image quality mode changes each time you press the **PIC** button.

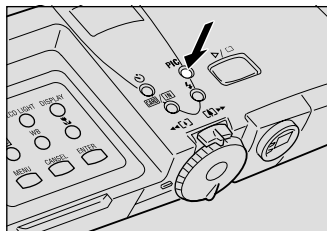

The selected image quality mode will be displayed.

If the keep settings function is enabled, the mode in effect when the camera is turned off will be saved.

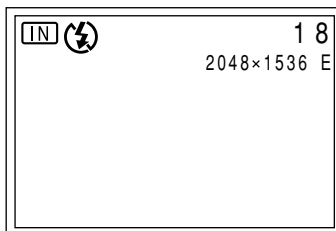
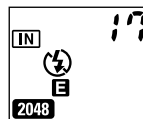

● Data Guide

Size (No. of Pixels)	Image Quality (Compression Rate)	F Fine	N Normal	E Economy
		2048 2048 × 1536	Approx. 1.12 MB/image	Approx. 568 KB/image
1024 1024 × 768	Approx. 376 KB/image	Approx. 184 KB/image	Approx. 88 KB/image	
640 640 × 480	Approx. 152 KB/image	Approx. 72 KB/image	Approx. 40 KB/image	

- Note**
- Image sizes are 2048 × 1536 pixels, 1024 × 768 pixels and 640 × 480 pixels. With this product and in this manual, the number of pixels is shown as **2048**, **1024** and **640**.
 - For the number of recordable images by image quality mode, see “Recording Capabilities” →(p.122).
 - Higher image quality can be obtained at 3072 × 2304, etc. “Switching to PRO Mode” → (p.70).

Setting the Size of the Subject (Zoom)

By moving the zoom lever, you can vary the size of the subject without changing the distance between yourself and the subject (zoom range is equivalent to 35 - 105mm in 35mm camera format).

① Move the zoom lever to [▲] or [▼].

Move to [▲] to increase the size of the subject (TELE), and move to [▼] to decrease the size of the subject (WIDE).

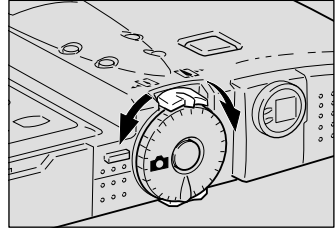

The zoom indication bar will be displayed on the LCD monitor.

Adjust the subject to the desired size.

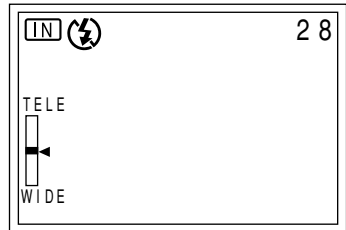

■ Digital Zoom Function

If you keep moving the zoom lever to [▲] for more than 2 seconds when the camera is set on (still picture mode) and the Image quality mode is **640** and the lens is at the maximum telephoto position or the camera is in macro mode (is displayed), the digital zoom function is triggered to magnify your shot 1.3 times, 1.6 times or 3.2 times.

To disable the digital zoom function, move the zoom lever to [▼].

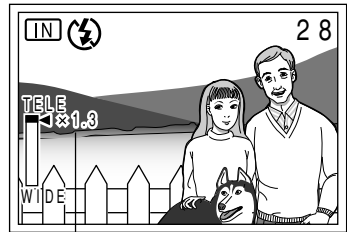

Magnification

- Note**
- The digital zoom function can be used when the Image quality mode is **640**. It cannot be used in the following situations: when the shooting mode is set on (sound), (text), (continuous shooting) or (motion picture)
when the image quality mode is set on non-compressed (NC) or PRO (PRO • PRO-L • PRO-H)
when LCD monitor is closed
 - Decide the composition using the LCD monitor and take the picture.

Checking the Position of the Subject

Check the position of your subject through the viewfinder or on the LCD monitor.

■ Viewing Through the Viewfinder

Aim the camera at the subject while looking through the viewfinder.

● Shooting Scope

Frame the subject within the viewfinder.

● Short Distance Correction Frame

Compose your subject within this range when the distance to the subject is less than about 24cm.

● Autofocus Field

Located in the center of the viewfinder and roughly corresponding to the area shown on the right, the autofocus field determines the focal distance.

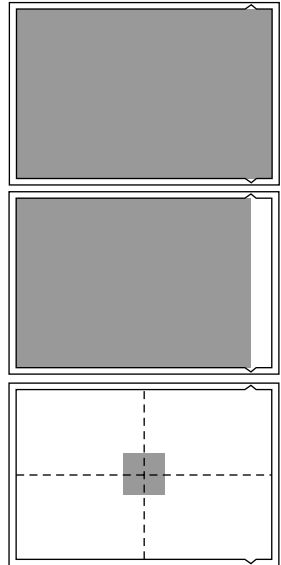

2

Shooting

■ Viewing on the LCD Monitor

Aim the camera at the subject while looking at the LCD monitor.

● Shooting Scope

Frame the subject within the LCD monitor screen.

● Autofocus Field

Located in the center of the LCD monitor screen and roughly corresponding to the area shown on the right, the autofocus field determines the focal distance.

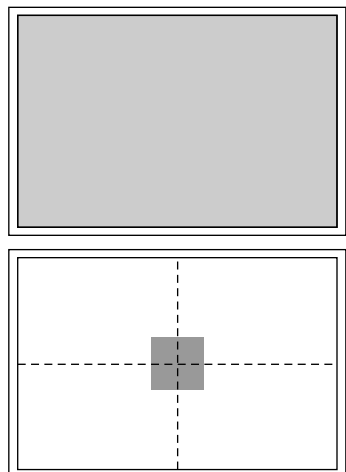

Note • The shaded area and dotted lines are shown for illustration purposes only and do not actually appear in the viewfinder or on the LCD monitor.

Shooting (Still Picture Mode)

Shooting instructions for still picture mode are given below. Hold the camera correctly to keep it steady.

1 Aim the camera at your subject.

- Note**
- Use macro mode to shoot subjects closer than 24cm. See “Close-up Shooting (Macro Mode)” → (p.60)

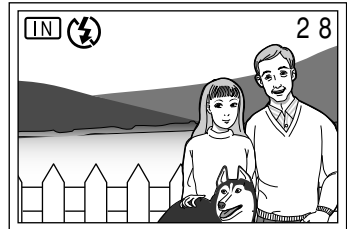

2 Use the zoom lever to set the size of the subject.

- See**
- “Setting the Size of the Subject (Zoom)” (p.44)
 - “Checking the Position of the Subject” (p.45)

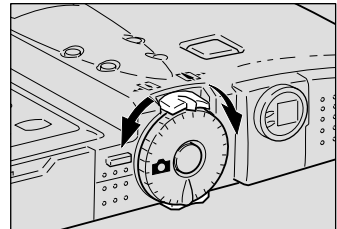

3 Press the shutter release button lightly with your fingertip.

The shutter button works in a two-step action. When you press it lightly (halfway), the autofocus function is triggered to determine the focal distance. Keep the camera as steady as possible to prevent camera shake.

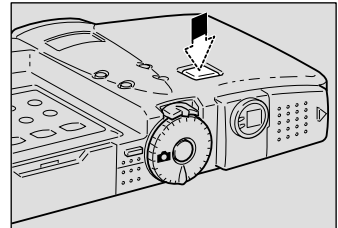

The AF LED (green) will light when the subject is in focus. The focus, exposure and white balance settings are set at this point.

- Note**
- A flashing AF LED indicates that the subject is out of focus. If this occurs, use the focus lock function. See “Focus Lock Shooting” → (p.61).
 - If the “SLOW SHUTTER” message appears on the LCD monitor, you are recommended to shoot with the flash enabled to avoid camera shake which tends to occur in this situation. See “Changing Flash Modes” → (p.53).

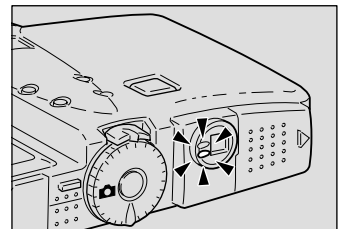

● Flash LED

The flash LED (red) lights when you press the shutter button lightly in low light conditions.

- Note** • The flash LED (red) blinks and the LCD monitor is cleared while the flash is charging. Pictures cannot be taken in this state.

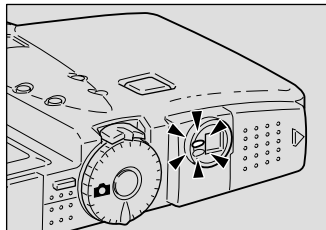

4 Press the shutter release button down fully without removing your finger.

A beep will sound and the picture you have taken appears on the LCD monitor before it is recorded.

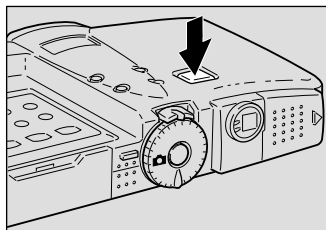

- Note** • Moving the camera before the beep sounds may result in a blurred image.
- You can incorporate sound into your recording. See “Still Picture/Text Shooting with Sound” → (p.52).



How to Cancel Recording

When you press down the shutter button fully, the shot image will appear on the LCD monitor. To cancel recording, press the  button, and then press the shutter button when the cancel confirmation message is displayed.

ERASE THIS IMAGE?
START : RELEASE
CANCEL : CANCEL

You can change the image confirmation time as desired. See “Changing LCD Confirmation Time” → (p.100).

Important Note

- Do not open the battery cover or card door or detach the AC adapter during recording.
 - The AF LED and Recording destination ( • ) will blink while the image is being recorded. Do not rotate the mode dial or turn off the power until recording has been completed.
- It is not possible to use the  button or use the MENU button to display the menu screen while an image is being recorded.



Using the Camera for Extended Periods of Time

The camera will turn off automatically (auto power off) to conserve the battery if it is left idle (no buttons or switches operated) for a preset time. When you require more time to compose a shot, disable the auto power off feature. When using the camera for an extended period of time, have a spare battery or AC adapter (optional) handy. See “Auto Power Off Setting” → (p.100).

■ When Focusing is Difficult

You may experience difficulty focusing on the following subjects:

- Objects with little or no contrast (such as the sky, white walls, and car hoods)
- Flat two-dimensional objects with only horizontal lines and no significant protrusions or indentations
- Fast-moving targets
- Low brightness objects (in dark places)
- Strongly backlit objects and objects struck by strong reflected light
- Flickering objects (such as fluorescent lights)

When shooting subjects like these, focus on another subject that is located at about the same distance and then aim at the target with that focus setting. See “Focus Lock Shooting” (p.61) “Manual Focus Shooting” (p.62).



LCD Monitor Display Function

Each time you press the DISPLAY button, the display switches to show recording data, such as the recording mode, image quality mode, and recordable picture count.



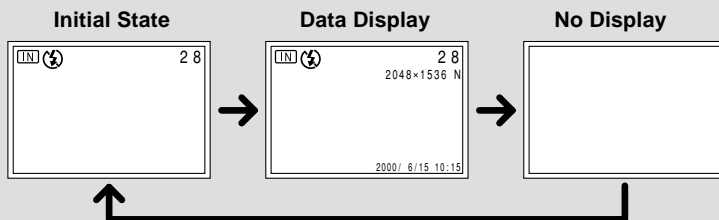

- Still picture mode



* In the case of sound mode or moving image mode (•), and the recordable time are displayed when the initial state or data display is displayed.

Special Shooting Functions

This section explains the various shooting functions. Depending on which recording mode you choose, the functions which can be used will vary. Refer to the following table.

Recording Mode		 Still Picture	 Sound	 Text	 Continuous	 Motion Picture
With Sound	p.52	○	×	○	×	×
Manual Focus	p.62	○	×	○	○	○
Flash strength	p.55	○	×	○	×	×
Red-Eye Reduction Mode	p.63	○	×	×	×	×
ISO Setting	p.64	○	×	○	○	×
Date Imprint	p.64	○	×	○	○	×
Soft Mode	p.65	○	×	×	○	×
Monochrome	p.66	○	×	×	○	○
Interval	p.67	○	×	○	×	×
Auto Bracket	p.68	○	×	×	×	×
Non-Compressed	p.69	○	×	×	×	×
PRO	p.70	○	×	○	×	×
TIME EXPOSURE	p.72	○	×	×	×	×

Text Shooting (Text Mode)

This mode is suitable to records text. The appropriate processing for recording text is adopted, and the text is recorded in dual value (black and white), to ensure clarity. (In this mode, the text can be recorded in less than 1/3 of the normal data volume.)

- 1 Set the mode dial to [].
- 2 Press the shutter release button to shoot the image.

The shot image appears on the LCD monitor before it is recorded.

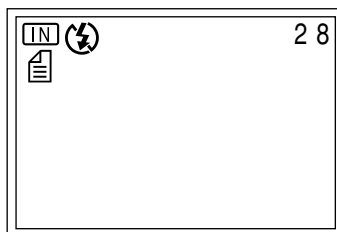

- Note**
- To cancel recording, press the  button while the shot image is displayed on the LCD monitor. See “Shooting (Still Picture Mode)” → (p.46)
 - Sound can be incorporated in the recording. See “Still Picture/Text Shooting with Sound” → (p.52).

Sound Recording (Sound Mode)

In this mode sound can be recorded. The recordable time is displayed according to the available capacity in the recording destination.



- The microphone is located on the front of the camera. Adjust the direction of the microphone to the best position for recording.

① Set the mode dial to [].

The recordable time is displayed.

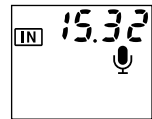

② Press the shutter release button to record.

Recording will start. The  mark blinks during recording and the recordable time is displayed.

To cancel recording, press the shutter release button again.

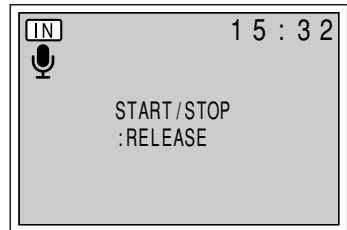

When the recording/recordable time exceeds 100 minutes, the first digit of the seconds is not displayed on the LCD monitor or LCD panel.

Continuous Shooting (Continuous Shooting Mode)

This mode is for shooting a subject continuously while the shutter button is depressed. This function is ideal for capturing special events.

① Set the mode dial to [].

② Press the shutter release button to shoot the image.

Shooting continues while the shutter release button is pressed.

Continuous shooting stops when you release the shutter release button.

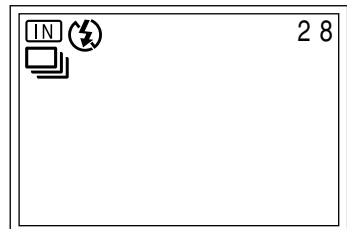

- The flash does not fire in continuous shooting mode.
- In continuous shooting mode, the focus, exposure compensation and white balance are locked in the status in effect when you press the shutter release button.
- Continuous shooting stops when the total number of files recorded reaches RIMG9999. In this case, format the SmartMedia memory card or internal memory to resume continuous shooting.



- In continuous shooting mode, no image appears on the LCD monitor while pictures are being taken.
- Do not open the battery cover or card door or detach the AC adapter (optional) during recording.
- The AF LED and Recording destination (**CARD** • **IN**) will blink while the image is being recorded. Do not rotate the mode dial or turn off the power until recording has been completed.
It is not possible to operate the **CARD** / **IN** button or use the MENU button to display the menu screen while an image is being recorded.

● Maximum number of continuous pictures

The maximum number of pictures that can be taken continuously depends on the image quality mode.

Image Quality (Compression Rate) Size (No. of Pixels)	F Fine	N Normal	E Economy
	2048 2048 × 1536	Approx. 5	Approx. 12
1024 1024 × 768	Approx. 17	Approx. 36	Approx. 70
640 640 × 480	Approx. 46	Approx. 89	Approx. 164

* The table shows the maximum number of pictures that can be taken continuously at one time. The available space on the SmartMedia memory card or internal memory may allow extended shooting.

Motion Picture Shooting (Motion Picture Mode)

This mode is for recording motion pictures. The recordable time is displayed according to the available capacity in the recording destination. Sound is incorporated in the recording.

① Set the mode dial to [].

The recordable time is displayed.

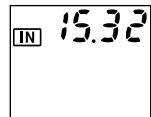

2 Press the shutter release button to shoot the image.

Shooting starts. The  mark blinks during shooting and the recording time is displayed on the LCD panel.

Press the shutter release button again to cancel recording.

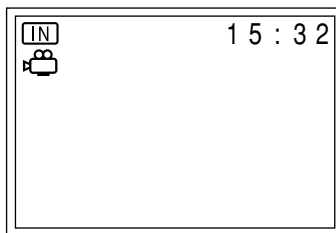

- Zoom does not work in motion picture mode.
- The flash does not fire in motion picture mode.
- The focus, exposure compensation and white balance are locked in the state in effect when the shutter button was pressed.

Still Picture/Text Shooting with Sound

This mode is for recording still pictures or text with 10 seconds of sound. This function is useful when you wish to add a comment or explain a situation.



- The microphone is located on the front of the camera. Adjust the direction of the camera to the best position for recording.

1 Set the mode dial to [] or [] and press the MENU button.

2 Press the or button to select [IMAGE WITH SOUND].

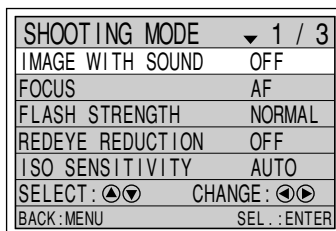

3 Press the or button to select [ON] and press the ENTER button.



4 Press the shutter release button to shoot the image.

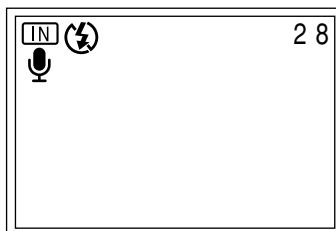



Sound is recorded for 10 seconds at the same time as shooting the image. The  mark blinks during sound recording.



- Note**
- The focus, exposure compensation and white balance are locked in the state in effect when the shutter button was pressed.
 - Sound recording starts after shooting in  (still picture) mode when the image quality mode is set on non-compressed (NC) or PRO (PRO, PRO-L, PRO-H), or in  (text) mode. In this case, make sure that the  mark blinks on the LCD panel during recording.

Changing Flash Modes







The camera offers four flash modes. Select the flash mode best suited to your photographic needs.

-  (Flash Off) : The flash is disabled even in dark conditions. Use this mode for shooting where use of the flash is prohibited or where adequate room illumination is available.
-  (Auto) : The flash fires automatically when it detects low ambient light or backlighting.
-  lit (Forced Flash) : When you take a picture against the light or under strong light, the subject's face may appear in the shade in the resultant shot. Use forced flash to reduce this effect. In this mode, the flash will fire regardless of the ambient light level.
-  blinking (Slow Synchro) : Slows down the shutter release speed when the flash is activated so that the subject is illuminated and the background is captured too. If you use this mode when you want to take a clear picture of your subject and capture the background atmosphere, such as at a party, it reduces the effect of only the background being darkened when the flash fires.

* The factory default setting is flash off mode  (Flash Off).

Effective Range of the Flash

When you shoot with the flash activated, the flash has an effective range of about 0.6 – 2.5m (23.7 – 98.5 inches) for the telephoto setting. The subject will appear dark in the picture if the light from the flash fails to reach it.

- 1 Set the mode dial to [] or [].
- 2 Press the  button to select the flash mode (, , , ).

The flash mode switches each time you press the button.

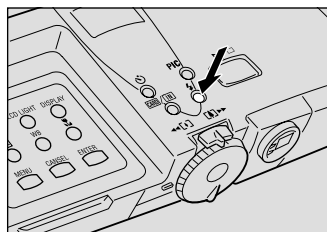

The selected flash mode will be displayed.
 In auto mode, the ⚡ mark appears only on the LCD monitor and not on the LCD panel.

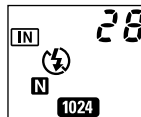

3 Press the shutter release button to shoot the image.

When the flash is activated, the flash LED (red) lights when you press the shutter release button lightly.

The flash LED blinks while the flash is charging and the LCD monitor is cleared. You cannot shoot during this time.

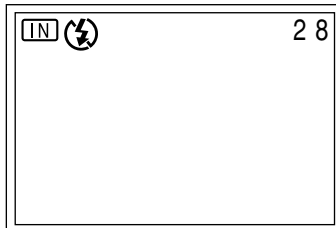

Important Note

- When you shoot a subject located closer than about 0.6m with the flash activated, light from the flash may appear red in the resultant picture. The subject may also appear white due to overexposure. To avoid this, switch to flash off mode.
- The shutter speed slows automatically when you shoot in dark places. To prevent camera shake, hold the camera steady or mount it on a tripod. Take care to avoid camera shake particularly when using the telephoto setting ([4]).

Note

- The flash will not fire in the following situations:
 - when the shooting mode is set on [M] (sound), [C] (continuous shooting) or [M] (motion picture)
 - when the white balance mode is set on [D] (daylight), [O] (overcast), [T] (tungsten light) or [F] (fluorescent light)
 - when in macro mode ([M])
 - during auto bracket shooting
- Enable the keep settings mode to save the flash mode setting. See “Keep Settings” → (p.99).
- When shooting a subject with the flash activated, if the subject appears dark on the LCD monitor, switch to a wider angle. The subject may be difficult to focus on with the telephoto setting.
- Shooting in the red-eye reduction mode will lessen the red-eye phenomenon in the resultant picture. See “Red-Eye Reduction Mode” → (p.63).

■ Adjusting the Strength of the Flash

When shooting with the flash activated (⚡^A, ⚡ lit, ⚡ blinking), you can adjust the strength of the flash.

- 1 Set the mode dial to [📷] or [📷] and press the MENU button.
- 2 Press the ▲ or ▼ button to select [FLASH STRENGTH].
- 3 Press the ◀ or ▶ button to select the desired strength (NORMAL, STRG or SOFT) and press the ENTER button.
- 4 Press the MENU button.
If you select STRONG, + is displayed on the LCD monitor, and if you select SOFT, – is displayed. There is no display when you select NORMAL.
- 5 Press the shutter release button to shoot the image.

SHOOTING MODE	▼ 1 / 3
IMAGE WITH SOUND	OFF
FOCUS	AF
FLASH STRENGTH	NORMAL
REDEYE REDUCTION	OFF
ISO SENSITIVITY	AUTO
SELECT: ▲▼	CHANGE: ◀▶
BACK: MENU	SEL.: ENTER

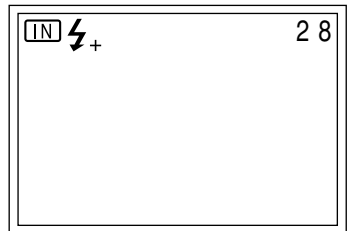

- Note** • Enable the keep settings mode to save the flash brightness setting. See “Keep Settings” → (p.99).

Setting the Exposure Compensation

As long as the subject is centered in the shooting range, you can take the picture normally as the camera will automatically adjust the exposure compensation for backlighting. If there is a significant difference in brightness between the background and subject, however, the subject tends to be under- or over-exposed. Exposure compensation is useful in this situation. You can also use exposure compensation to produce intentionally under- or over-exposed images.

● Exposure Compensation Range

± 2.0 EV (in 0.5 EV steps)

● Shooting Against the Light

The bright background will make the subject appear underexposed. Set the exposure compensation level to a positive (+) value to adjust the exposure.







- If the subject is not centered in the shooting range when taking a picture against the light, the camera will not assume that the subject is in a backlit state. Exposure compensation is required in this situation.

● Shooting a White Image





If you shoot an image that appears generally white, the shot will be underexposed as a whole, with people appearing dark and white objects appearing gray. Set the exposure compensation level to a positive (+) value to adjust the exposure.

● Shooting a Black Image

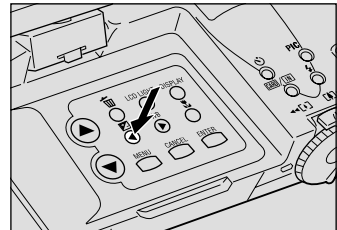
If you shoot an image that appears generally black, the shot will be overexposed as a whole, with people appearing white and black objects appearing gray. Set the exposure compensation level to a negative (-) value to adjust the exposure. Follow the same procedure when shooting a person under a spotlight, for example.

- 1 Set the mode dial to one of the following [   ] and press the  button.



- 2 Press the  or  button to change the exposure compensation value and press the ENTER button. Press the  button to increase the compensation level, and press the  button to decrease the compensation level. Continuously pressing the button changes the level continuously.

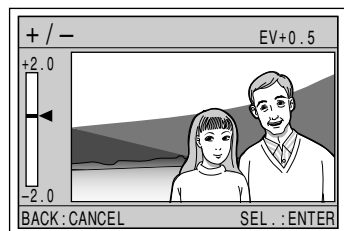

- ③ Press the shutter release button to shoot the image.

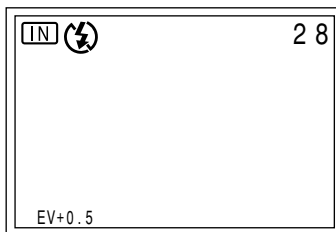

- Note**
- Enable the keep settings mode to save the exposure compensation level setting. See “Keep Settings” → (p.99).
 - You can take 3 frames in succession at exposure compensation levels of -0.5 EV, 0, and +0.5 EV based on the preset compensation level. See “Auto Bracket Shooting” → (p.68).

Changing the White Balance

The white balance mode adjusts the white balance so that you can capture your subject in its natural colors regardless of the light source. The auto mode will suffice in most situations.

The auto mode automatically adjusts the white balance based on the white areas, ensuring that white is reproduced as white regardless of the light source. Consequently, a subject that lacks in white tones as a whole or that is dominated by dark tones may not achieve an appropriate white balance. Change the white balance mode to shoot such subjects.

- No display (Auto) : The camera automatically adjusts the white balance.
- ☀ (Daylight) : This mode is used to shoot subjects outdoors where an appropriate white balance is difficult to achieve.
- ☁ (Overcast) : This mode is used to shoot subjects outdoors under cloudy skies or in shade where the appropriate white balance is difficult to achieve.
- 🔥 (Tungsten Light) : This mode is used to shoot subjects under tungsten light where an appropriate white balance is difficult to achieve.
- 💡 (Fluorescent Light) : This mode is used to shoot subjects under fluorescent light where an appropriate white balance is difficult to achieve.





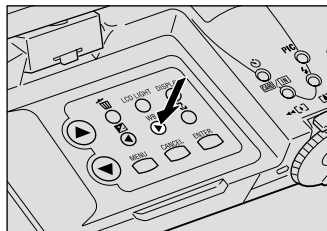

* The factory default setting is auto mode.

Subjects Difficult to Correct in Auto Mode

- Monochrome subjects
- Subjects lit by multiple light sources

- 1 Set the mode dial to one of the following [ •  •  • ] and press the WB button.



- 2 Press the  or  button to select the white balance (AUTO •  •  •  • ) and press the ENTER button.

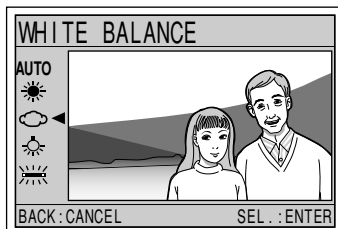



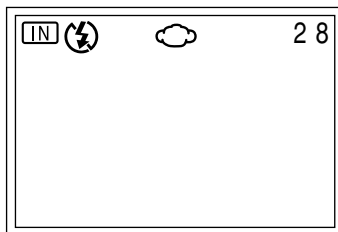

- 3 Press the shutter release button to shoot the image.



- The color tones of a subject will vary depending on weather conditions or light source (tungsten light or fluorescent light).



- In auto mode, subjects lacking in white tones may not achieve an appropriate white balance. When shooting such subjects, add a white object to the composition.
- The flash will not fire in the following white balance modes:  (daylight),  (overcast),  (tungsten light), and  (fluorescent light).
- Enable the keep settings mode to save the white balance mode setting. See “Keep Settings” → (p.99).

Using the Self-Timer

The self-timer offers a convenient way to take group pictures with the photographer included. Mount the camera on a tripod or set it on a flat surface to shoot pictures with the self-timer.

2 Set the mode dial to [] or [] and press the button.

The self-timer is now set.

The  mark will be displayed on the LCD monitor and LCD panel.

- Note**
- The self-timer setting is canceled when you press the  button again, when you set the mode dial to another mode, or when you turn the camera off.

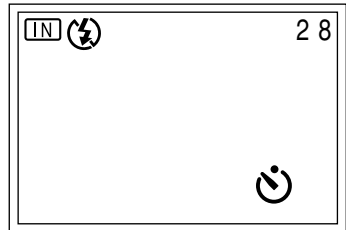
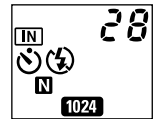
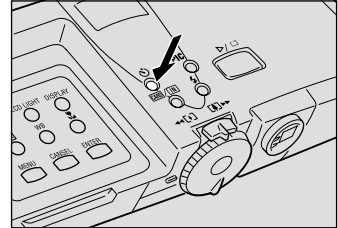

2 Decide the composition of the picture, position the camera securely, and press the shutter release button.

The self-timer LED lights and the self-timer starts. The shutter is released after a delay of approximately 10 seconds. The self-timer LED starts to flash about 2 seconds before the shutter is released and the beep sound is heard. The self-timer mode is automatically canceled when the shutter is released.

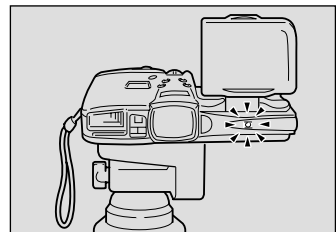

- Note**
- If the flash is charging, the self-timer will start when charging is completed.
 - The focus is locked at the point when the shutter release button is pressed.



Remote Control

To operate the camera from a remote position or when the camera is fixed in one spot, use the optional remote control unit.

Close-up Shooting (Macro Mode)

Macro photography allows you to take a close-up picture of a subject. Macro mode is recommended for taking pictures at a distance of less than 24cm (9.5 inches) from the subject.

- 1 Set the mode dial to one of the following [ •  •  • ] and press the  button.

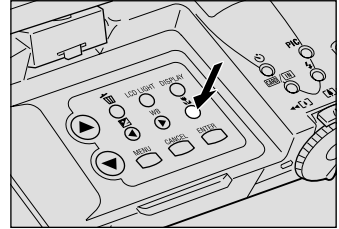

The mark will be displayed on the LCD monitor.

- Note** • Macro shooting is canceled when you press the  button again, when you set the mode dial to another mode, or when you turn the camera off.

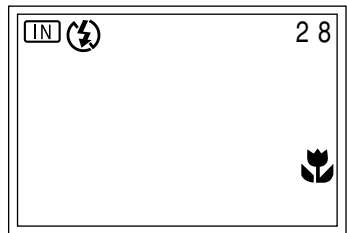

- 2 Bring the camera close to the subject and decide the composition of the picture. Press the shutter release button lightly to set the focus.
- 3 Press the shutter release button to shoot the image.

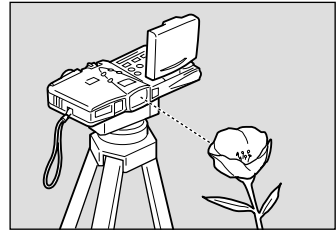

- The focusing range is so small in macro mode that the focus can be lost if the camera is moved. Make sure the camera is firmly positioned by mounting it on a tripod, for example, to keep it steady when shooting.
- As there is a wide margin between the field of view through the viewfinder and the shooting range, check the shooting range on the LCD monitor or with the camera connected to a TV.



Shutter release button

The optional remote control unit is convenient for when the camera is mounted on a tripod or similar device and the shutter release button is difficult to press.



- The flash will not fire in macro mode.

Focus Lock Shooting

Usually, the auto focus function focuses the camera on the subject that appears in the autofocus field on the LCD monitor or in the viewfinder. If the subject is located outside the autofocus field, it may appear blurred in the resultant shot. Use the focus lock to ensure accurate focusing on the subject.

See • “Checking the Position of the Subject” (p.45).

■ When to Use the Focus Lock

If the subject is not positioned inside the autofocus field, a blurred image will result as the background, not the subject, is in focus.

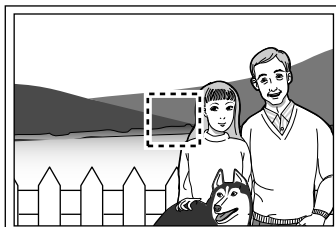

If an object other than the subject occupies a major portion of the autofocus field, the camera will focus on the object, producing a blurred image of the people.

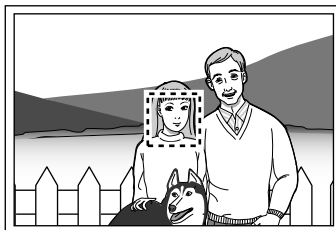

■ How to Use the Focus Lock

- 1 Use the zoom lever to set the size of your subject.

See • “Setting the Size of the Subject (Zoom)” (p.44).

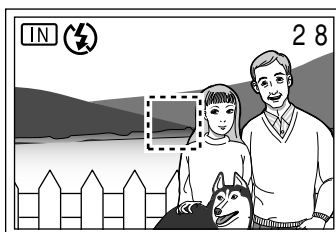

- 2 Bring the subject on which you wish to focus into the autofocus field.

- 3 Press the shutter release button lightly and hold it.

The focus will be locked at this point and the AF LED (green) will light.

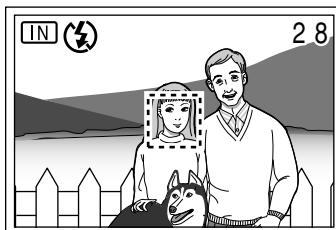

- Decide the composition of the picture by moving the camera with the shutter release button held, and then press the shutter release button down fully.

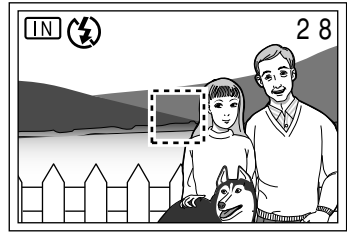

Note • You can also use the manual focus to focus on the subject. See “Manual Focus Shooting” → (p.62).

Manual Focus Shooting

The manual focus function can be used to manually adjust the focal setting for subjects difficult to bring into focus with the autofocus.

- Set the mode dial to one of the following [• • •] and press the MENU button.
- Press the or button to select [FOCUS].
- Press the or button to select [MF] and press the ENTER button.

Note • The manual focus setting is canceled when you select [AF] or when you turn the camera off.

SHOOTING MODE	▼ 1 / 3
IMAGE WITH SOUND	OFF
FOCUS	AF
FLASH STRENGTH	NORMAL
REDEYE REDUCTION	OFF
ISO SENSITIVITY	AUTO
SELECT :	CHANGE :
BACK: MENU	SEL. : ENTER

- Press the MENU button.
[MF] will be displayed on the LCD monitor.



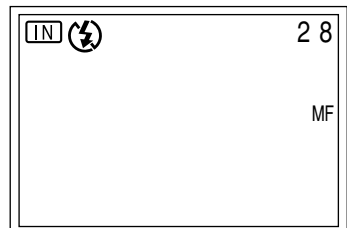

- Press the or button to focus on the subject and press the shutter release button to take the picture.
To vary the size of the subject, press the zoom button.



Note • Enable the keep settings mode to save the focus mode setting. See “Keep Settings” → (p.99).

Red-Eye Reduction Mode

If you shoot a subject in a dark place with the flash activated, the eyes of the subject may appear red in the resultant picture. In red-eye reduction mode, the flash will fire several times before the shutter releases to lessen the red-eye phenomenon.

- 1 Set the mode dial to [] and press the MENU button.
- 2 Press the  or  button to select [REDEYE REDUCTION].
- 3 Press the  or  button to select [ON] and press the ENTER button.
- 4 Press the MENU button.

 will be displayed on the LCD panel or LCD monitor.

- 5 Press the shutter release button to shoot the image.





When you press the shutter release button, the flash will fire several times in succession preliminarily before firing when the shutter releases.



- The shutter takes about 1 second to release after you press the shutter button. Hold the camera steady meanwhile to shoot the picture.







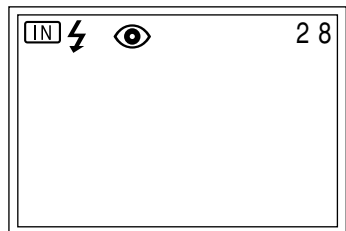
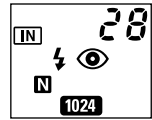

- You cannot use the red-eye reduction mode when the flash mode is set on  (flash off).

SHOOTING MODE	▼ 1 / 3
IMAGE WITH SOUND	OFF
FOCUS	AF
FLASH STRENGTH	NORMAL
REDEYE REDUCTION	OFF
ISO SENSITIVITY	AUTO
SELECT :  	CHANGE :  
BACK : MENU	SEL. : ENTER







Changing the ISO Setting

You can change the ISO sensitivity.

- 1 Set the mode dial to one of the following [ •  • ] and press the MENU button.
- 2 Press the  or  button to select [ISO SENSITIVITY].
- 3 Press the  or  button to select the desired ISO setting (AUTO • 200 • 400) and press the ENTER button.
- 4 Press the MENU button.

The ISO setting will be displayed on the LCD monitor. There is no display when the setting is on AUTO.

- 5 Press the shutter release button to take the picture.

SHOOTING MODE	▼ 1 / 3
IMAGE WITH SOUND	OFF
FOCUS	AF
FLASH STRENGTH	NORMAL
REDEYE REDUCTION	OFF
ISO SENSITIVITY	AUTO
SELECT :  	CHANGE :  
BACK:MENU	SEL.:ENTER

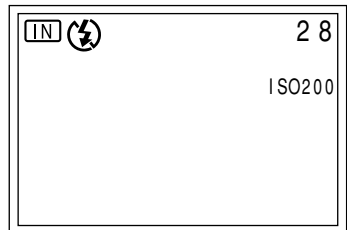

- Note** • Enable the keep settings mode to save the ISO setting. See “Keep Settings” → (p.99).

Date Imprinting

Use this mode to record images imprinted with the date.

- Note** • This function is only available if the date has been set in the settings menu, so set the date first. The date is displayed in the style selected on the date setting menu. See “Setting the Date and Time” → (p.34).

- 1 Set the mode dial to one of the following [ •  • ] and press the MENU button.

② Press the ▲ or ▼ button to select [DATE IMPRINT].

③ Press the ◀ or ▶ button to select [DATE] or [DT/TM] and press the ENTER button.

④ Press the MENU button.

If you select [DT/TM], the date and time are displayed (e.g. 2000/5/15 10:15), and if you select [DATE], the time is displayed (e.g. 2000/5/15).

⑤ Press the shutter release button to shoot the image.

SHOOTING MODE	◆ 2 / 3
DATE IMPRINT	DATE
SOFT MODE	OFF
MONOCHROME MODE	OFF
INTERVAL MODE	➡
AUTO BRACKET	OFF
SELECT : ▲▼	CHANGE : ◀▶
BACK:MENU	SEL.:ENTER

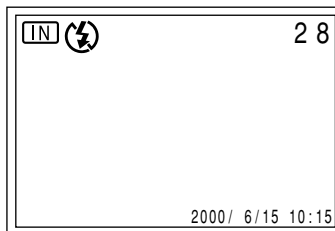

Note • Enable the keep settings mode to save the date imprint setting. See “Keep Settings” → (p.99).

Soft Mode

Smooths the contours when photographing people, faces or flat objects such as walls, etc.

① Set the mode dial to [📷] and press the MENU button.

② Press the ▲ or ▼ button to select [SOFT MODE].

③ Press the ◀ or ▶ button to select [ON] and press the ENTER button.

④ Press the MENU button.

[SOFT] will be displayed on the LCD monitor.

SHOOTING MODE	◆ 2 / 3
DATE IMPRINT	OFF
SOFT MODE	OFF
MONOCHROME MODE	OFF
INTERVAL MODE	➡
AUTO BRACKET	OFF
SELECT : ▲▼	CHANGE : ◀▶
BACK:MENU	SEL.:ENTER

- 5 Press the shutter release button to shoot the image.

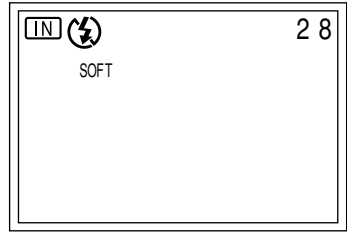

- Enable the keep settings mode to save the Soft setting. See “Keep Setting” → (p.99)

Monochrome Mode

Use this mode to shoot subjects in monochrome or sepia.

- 1 Set the mode dial to one of the following [• •] and press the MENU button.

- 2 Press the or button to select [MONOCHROME MODE].

- 3 Press the or button to select [B&W] or [SEPIA] and press the ENTER button.

Select [B&W] to shoot in black and white images or [SEPIA] to shoot in sepia images.

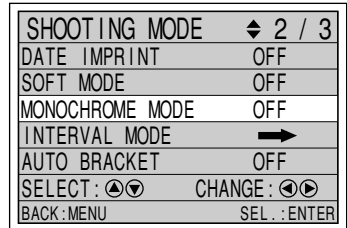

- 4 Press the MENU button.

- 5 Press the shutter release button to shoot the image.

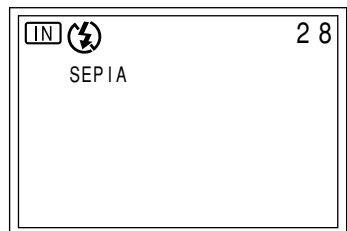

- The white balance mode does not function when you choose monochrome mode.

Interval Shooting

The camera can be set to take pictures automatically at preset intervals. The intervals can be set in steps of 30 seconds in the range of 30 seconds to 3 hours.

For example, if you set an interval of 1 hour, the shutter will be released every hour, taking pictures continuously until the internal memory or SmartMedia memory card runs out of available memory.



- Check the remaining number of pictures that can be stored on the SmartMedia memory card or internal memory before starting interval shooting.
- The auto power off function will be activated 24 hours after the start of interval shooting, even if the camera is powered by the AC adapter.

1 Set the mode dial to [] or [] and press the MENU button.

2 Press the or button to select [INTERVAL MODE] and press the ENTER button.

SHOOTING MODE	◆ 2 / 3
DATE IMPRINT	OFF
SOFT MODE	OFF
MONOCHROME MODE	OFF
INTERVAL MODE	➔
AUTO BRACKET	OFF
SELECT :	CHANGE :
BACK : MENU	SEL. : ENTER

3 Press the or button until the digit you want to set starts to flash.

4 Press the or button to change the value of the flashing digit.

Press the button to increase the value, and press the button to decrease the value. Pressing the button continuously increases the speed at which the digit changes.

Repeat steps **3** and **4** above to set the desired interval in steps of 30 seconds.

INTERVAL MODE	
0:10:00	
SELECT :	
BACK : CANCEL	SEL. : ENTER

5 Press the ENTER button again after setting the digit for the seconds.

The interval timer is now enabled.

- Note**
- The interval shooting mode is canceled when you set the mode dial to another mode or turn the camera off while the “INTERVAL” message is lit on the LCD monitor.

6 Press the shutter release button.

The camera will take the first shot and then proceed to shoot at the preset interval. The “INTERVAL” message flashes on the LCD monitor while interval shooting is in progress. Shooting will continue until the internal memory or SmartMedia memory card runs out of available memory.

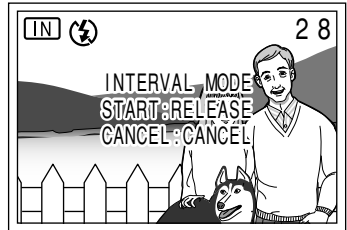





- Note**
- You can take normal shots by pressing the shutter button while interval shooting is in progress. The preset interval will not be affected.
 - The actual interval between shots may be longer than the preset time depending on the image quality and flash mode settings.
 - If the camera is powered by the battery, it is possible for the battery may run out during interval shooting. It is therefore recommended to use an AC adapter (optional) for interval shooting.





Auto Bracket Shooting

Auto bracket shooting allows you to take 3 frames in succession at exposure compensation values of -0.5 EV, 0 and $+0.5$ EV, based on the exposure compensation value set in “Setting the Exposure Compensation” (p.56).

To prevent camera shake, mount the camera on a tripod or set it on a flat surface when taking the pictures.

1 Set the mode dial to [] and press the MENU button.

- ② Press the  or  button to select [AUTO BRACKET].
- ③ Press the  or  button to select [ON] and press the ENTER button.
- ④ Press the MENU button.
AB will be displayed on the LCD monitor.
- ⑤ Press the shutter release button to take the pictures.

SHOOTING MODE	◆ 2 / 3
DATE IMPRINT	OFF
SOFT MODE	OFF
MONOCHROME MODE	OFF
INTERVAL MODE	→
AUTO BRACKET	OFF
SELECT :  	CHANGE :  
BACK:MENU	SEL.:ENTER

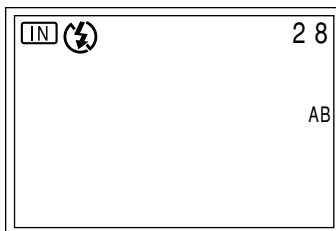

When you press the shutter release button, 3 frames are shot in succession at -0.5 EV, 0.0 and $+0.5$ EV, based on the preset exposure compensation value.

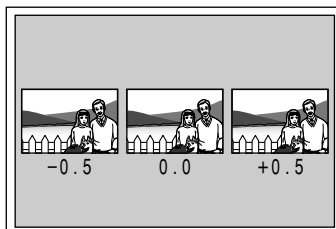

- Note**
- You cannot use the auto bracket function when the image quality mode is set on non-compressed (NC) or PRO (PRO, PRO-L, PRO-H), or when [IMAGE WITH SOUND] is set on [ON].
 - The flash does not fire in auto bracket mode.

Switching to Non-Compressed Mode

In normal image quality mode, the data is compressed at the time of recording. To record without compressing the data, set [NO-COMPRESSION] to [ON] to switch the image quality mode.

- ① Set the mode dial to  and press the MENU button.

2 Press the ▲ or ▼ button to select [NO COMPRESSION].

3 Press the ◀ or ▶ button to select [ON] and press the ENTER button.

4 Press the MENU button.

NC will be displayed on the LCD monitor or LCD panel.

5 Press the shutter release button to shoot the image.

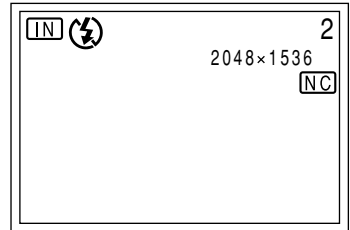
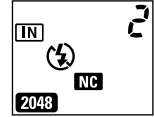
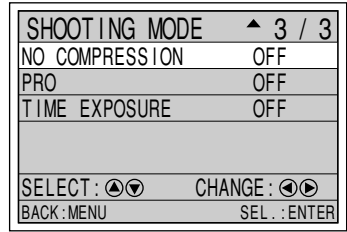

● Data Guide

Image Quality (Compression Rate) Size (No. of Pixels)	NC
2048 2048 × 1536	Approx. 6 MB/image
1024 1024 × 768	Approx. 1.5 MB/image
640 640 × 480	Approx. 640 KB/image

Switching to PRO Mode

This mode allows you to take pictures with enhanced image quality.

- PRO: PRO enables you to take pictures with a size of 3072 × 2304 pixels.
- PRO-L: PRO-L enables you to record sharp, high resolution images with the normal volume of data.
- PRO-H: PRO-H enables you to record high resolution images with a size of 3072 × 2304 pixels.



- When you take pictures using PRO-L or PRO-H mode, 2 shots are taken when you press the shutter release button. The subject is therefore limited to still objects, and the camera should always be mounted on a tripod.
- In some cases taking pictures in this mode may result in a large volume of data or a long shooting time. You should therefore check the volume of recordable memory and the battery level.

① Set the mode dial to [] or [] and press the MENU button.

② Press the or button to select [PRO].

③ Press the or button to select [OFF, PRO, PRO-L, PRO-H] and press the ENTER button.

④ Press the MENU button.

PRO mode will be displayed on the LCD monitor or LCD panel.

⑤ Press the shutter release button to shoot the image.

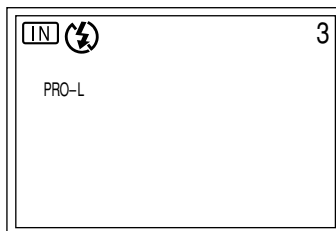
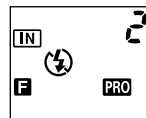
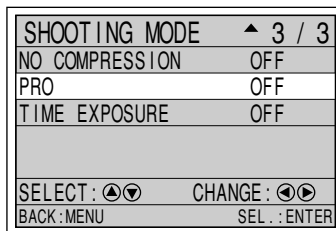

- To cancel recording, press the button while the shot image is displayed on the LCD monitor.

● Data Guide

Image Quality (Compression Rate)	Fine	Normal	Economy	NC
MODE/Size (No. of Pixels)				
PRO 3072 × 2304	Approx. 2.53 MB	Approx. 1.26 MB	Approx. 648 KB	Approx. 13.5 MB
PRO-L 2048 × 1536	Approx. 1.12 MB	Approx. 568 KB	Approx. 280 KB	Approx. 6 MB
PRO-H 3072 × 2304	Approx. 2.53 MB	Approx. 1.26 MB	Approx. 648 KB	Approx. 13.5 MB

● Shooting Time Data

Image Quality (Compression Rate) Mode	F Fine/ N Normal/ E Economy	NC NC
PRO	Approx. 35 sec.	Approx. 90 sec.
PRO-L	Approx. 35 sec.	Approx. 60 sec.
PRO-H	Approx. 70 sec.	Approx. 120 sec.





Setting the Time Exposure Mode

The time exposure mode is used when photographing bright subjects such as fireworks and racecars in a dark place.

This feature can be used in the still picture mode [].



- Mount the camera on a tripod, etc., when using the Time Exposure mode.

- 1 Set the mode dial to [] and press the MENU button.
- 2 Press the  or  button to select [TIME EXPOSURE].
- 3 Press the  or  button to select the exposure time (OFF, 1 SEC., 2 SEC., 4 SEC., 8 SEC.) and press the ENTER button.
- 4 Press the MENU button.
- 5 Press the shutter release button to shoot the image.

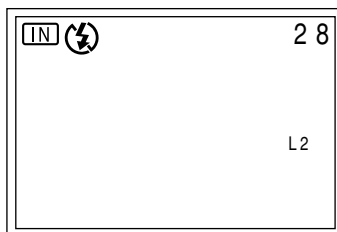
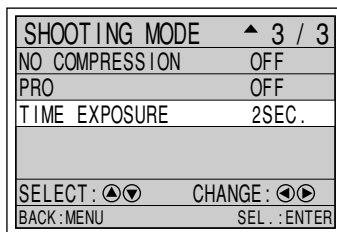

- The time exposure mode cannot be set in the PRO mode (PRO, PRO-L, PRO-H) or auto bracket shooting.

PLAYBACK Chapter

3

Before Starting to Playback	
Recorded Images	74
Files That Can Be Played on the Camera	74
Connecting to a TV	74
Playing Back a File	76
Playing a Still Picture/Text/Continuous File	76
Playing a Sound File	77
Playing a Motion Picture File	78
Special Playback Functions	80
Multi Image Playback	80
Zoom Playback	81
Auto Playback	82
Rotating a Displayed File	82
Copying Image Files	83
Playing a File Shot with a Non-Ricoh Camera	84
Protecting a File	85
Setting DPOF (Digital Print Order Format)	86
Setting Printing Services	86

Before Starting to Playback Recorded Images

This section explains what kind of files can be played back on the camera and how to play back recorded images using a TV.

Files That Can Be Played on the Camera

The following kinds of files can be played on this camera:

- Files recorded on this camera
- Files transferred from a PC using Ricoh software compatible with this camera
- Files recorded with a non-Ricoh camera. See “Playing a File Shot with a Non-Ricoh Camera” (p.84).

- Note**
- The [UNMATCHED FILE] message will be displayed if an unplayable file is encountered.
 - Data recorded on the Ricoh DC-3Z/DC-4 or RDC-5000* series can also be displayed.
* Zoom playback is not possible.

Connecting to a TV

Connect the camera to a TV set with the AV interface cable supplied to play recorded files on the TV screen.

- See**
- Refer to the instruction manual for the equipment to which the camera is connected.

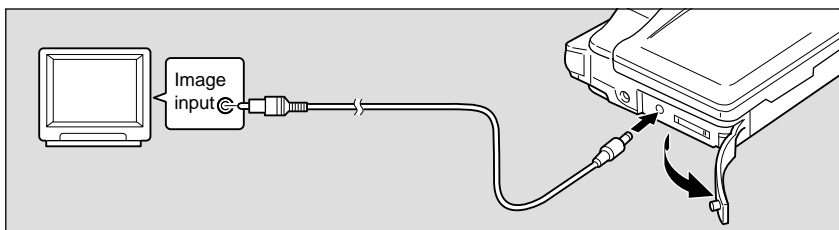

- ① Check that both the camera and the TV are turned off.
- ② Open the terminal cover on the camera and connect the AV interface cable to the AV out terminal.
- ③ Connect the other end of the AV interface cable to the Video In terminal on the TV.

Using the Camera for an Extended Period of Time

Supplying power to the camera from a household AC outlet using an optional AC adapter is recommended for shooting over an extended period of time. See "Using an AC Adapter" → (p.26)



* Make sure that the camera is turned off before connecting the AC adapter.



- Note**
- When you are away on overseas trips, you may view recorded images on a TV set with the other Video-out signal method (NTSC/PAL). See "Changing the Video-out Signal Method" → (p.103).
 - When you connect the camera to a TV, the screen displayed on the LCD monitor appears on the TV monitor.

Playing Back a File

This section provides instructions for playing back recorded files.

Playing Back a Still Picture/Text/Continuous File



Follow the procedure below to play files recorded in  (still picture),  (text) or  (continuous shooting) mode, and still picture or text files with sound.

- 1 **Set the mode dial to [] and press the [] button to select the playback source.**

The most recently recorded file is played back on the LCD monitor.

 • “Information Displays” (p.7).

- 2 **Press the  or  button to select a file to be played back.**

Press the  button to display the next file, and press the  button to display the previous file. Keeping the button pressed increases the speed.

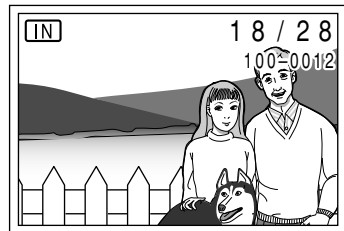



● Still Picture and Text Files with Sound

To play back a sound file, press the shutter release button.

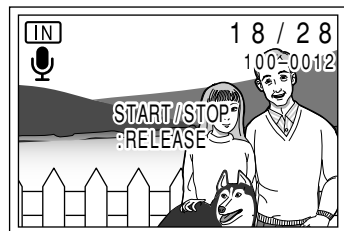
Playback of a sound file ends automatically. To pause playback, press the shutter release button again or the  button.



 • You can adjust the volume by pressing the  or  button. See “Playing a Sound File” → (p.77).

● Playback Display

Pictures taken in the following image sizes will appear on the LCD monitor or TV monitor as shown below.

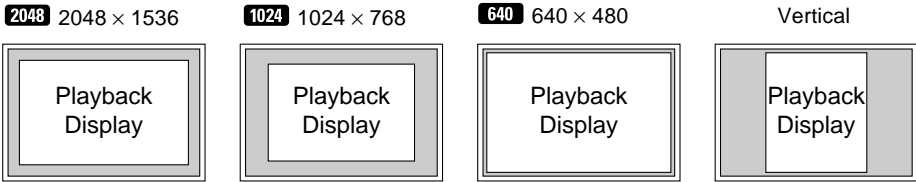



- Files may take a while to play after the camera is turned on or the mode dial is set, depending on the capacity of the SmartMedia memory card.
- Files that have been recorded in  (continuous shooting) mode are recorded as single files and therefore can be played the same way as regular files.
- You can protect files from being erased. See “Protecting a File” → (p.85).



Playing a Sound File

Follow the procedure below to play files recorded in  (sound) mode.



- The speaker is located on the side of the camera. Place the camera in the best position for playback.

① Set the mode dial to [] and press the  button to select the playback source.

② Press the  or  button to select a sound file and press the shutter release button.

The sound will be played back, and the playback indicator and time elapsed will be displayed.

Playback of a sound file ends automatically. To pause playback, press the  button.

● To pause/resume Playback

If you press the shutter button during playback, playback will be suspended. To resume playback, press the shutter button again.

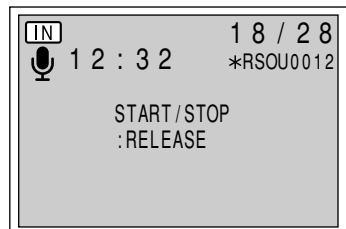

If you keep the zoom lever moved while playback is suspended, you can fast forward by moving to [▲] or rewind by moving to [◀].

● Adjusting the Volume

If you press the ◀ or ▶ button during playback, the volume adjustment indicator will be displayed. Press the ◀ or ▶ button to adjust the volume.

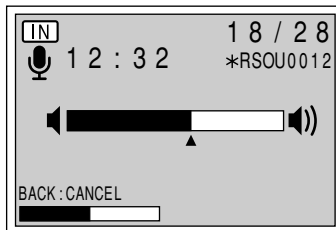

- Note**
- When connected to a TV set, etc., use the connected device to adjust the audio volume.
 - When the recording/recordable time exceeds 100 minutes, the first digit of the seconds is not displayed on the LCD monitor or LCD panel.
 - You can protect sound files from erasure. See “Protecting a File” → (p.85).

Playing a Motion Picture File

Follow the procedure below to play a file recorded in  (Motion Picture) mode.

- 1 Set the mode dial to [▶] and press the [CARD]/[IN] button to select the playback source.**
- 2 Press the ▲ or ▼ button to select a moving image file and press the shutter release button.**

The motion picture file will be played, and the playback indicator and time elapsed will be displayed.

Playback of a motion picture file ends automatically. To discontinue playback, press the ▼ button.

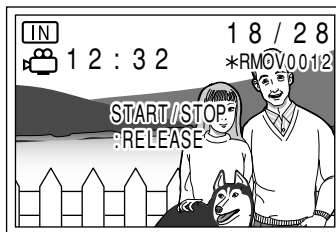

● To pause/resume Playback

If you press the shutter button during playback, playback will be suspended. To resume playback, press the shutter button again.

● **Single frame forward/reverse, slow playback/reverse slow playback**

While playback is being suspended, move the zoom lever to [▲] to advance single image; move the zoom lever to [▼] to return one frame. Also, keeping the zoom lever to [▲] starts slow playback and keeping the zoom lever to [▼] starts reverse slow playback.

- **Note** • You can adjust the volume by pressing the ◀ or ▶ button. See “Playing a Sound File” → (p.77).
- You can protect a motion picture file to prevent erasure of the file. See “Protecting a File” → (p.85).

◆ **Tips**

Display Function

Each time you press the DISPLAY button, the information display switches between the date and time recorded, image quality mode, etc.

● **Still Picture/Text/Continuous File**

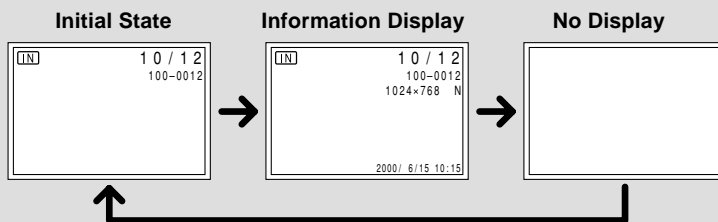

* In the case of a sound file or motion picture file, 🎧, 🎞️, the time elapsed and the indicators are displayed when the initial state or information display is displayed.



Special Playback Functions

This section explains the various playback functions.

Multi Image Playback

Multi-image playback lets you view six images at once on the LCD monitor for quick searching.

- 1 Set the mode dial to [] and press the MENU button.

- 2 Press the  or  button to select [MULTI IMAGE] and press the ENTER button.

The LCD monitor will switch to the six-image display.

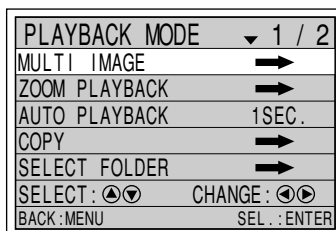

- 3 Press the  or  button and the  or  button to select a file to be played back.

Six files at a time are displayed, with the position in which each file is displayed determined by the file number.

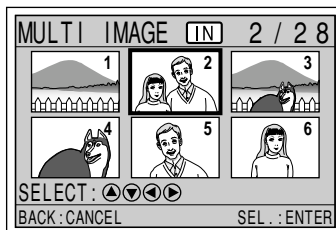

The file enclosed in a thick frame is the selected file.





- 4 Press the ENTER button.

The LCD monitor will return to the normal screen and the selected file will be displayed in the single-image mode.

- Note** • Unplayable files are displayed in black. The following files can be displayed on the blue screen.

Sound	 mark on blue screen
Text	 mark on blue screen
Text + Sound	 mark on blue screen



- To display the previous set of six files, press the  button when the selected file is on the top row, and to display the next set of six files, press the  button when the selected file is on the bottom row.

Zoom Playback

The image file being played is magnified both in height and width. Depending on the size of the image, images can be displayed in the following magnifications.

- 2048 × 1536: 1.3X, 1.6X, 3.2X
- 1024 × 768: 1.6X
- 640 × 480: 2X
- 3072 × 2304: 2.4X

❶ Set the mode dial to [] and press the MENU button.

❷ Press the  or  button to select [ZOOM PLAYBACK] and press the ENTER button.

The screen will switch to the zoom display.

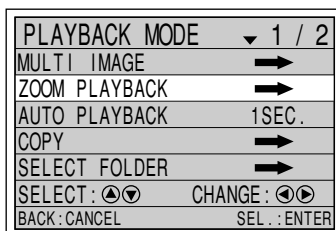

❸ Press the  or  button and the  or  button to verify the file.

To shift the display position, press the buttons while looking at the window.

● Changing the Magnification

The magnification changes each time you press the ENTER button when the image size is **2048**.

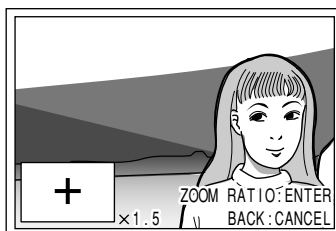





❹ After confirming the file, press the CANCEL button.

The screen will return to the play mode display.





- Note**
- Magnifiable files are still picture files, text files, and still picture/text files with sound that have been recorded on this camera.
 - The magnification displays for other files that can be played are approximate.
 - Vertically recorded images can be displayed horizontally by setting zoom playback mode.

Auto Playback

This function automatically plays all the files stored in the internal memory or on the SmartMedia memory card.

- 1 Set the mode dial to [] and press the MENU button.
- 2 Press the  or  button to select [AUTO PLAYBACK].
- 3 Press the  or  button to select the playback time (1 SEC., 3 SEC., 5 SEC., 10 SEC., 30 SEC., 60 SEC.) and press the ENTER button.

When you press the ENTER button, playback starts automatically for the specified time. Playback continues until canceled.

PLAYBACK MODE	▼ 1 / 2
MULTI IMAGE	→
ZOOM PLAYBACK	→
AUTO PLAYBACK	1SEC.
COPY	→
SELECT FOLDER	→
SELECT :  	CHANGE :  
BACK : CANCEL	SEL. : ENTER

● How To Cancel Auto Playback





Press any button, such as the shutter release button or zoom button, during auto playback.

- Note**
- The time it takes to recall a file is not included in the playback time.
 - Still picture/text files with sound, motion picture files and sound files are played for the time the sound or image was recorded, regardless of the preset playback time.

Rotating a Displayed File

You can rotate a recorded file 90 degrees to the right, 90 degrees to the left, or 180 degrees on the display.

- 1 Set the mode dial to [] and press the MENU button.

- ② Press the  or  button to select [ROTATION].
- ③ Press the  or  button to select the angle (R90°, L90°, 180°) and press the ENTER button.

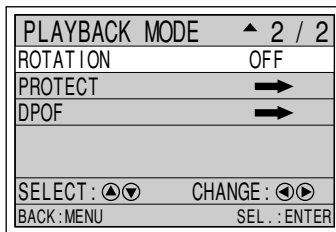

When you press the ENTER button, the file will be displayed at the specified angle .

Rotated 90 degrees to the right

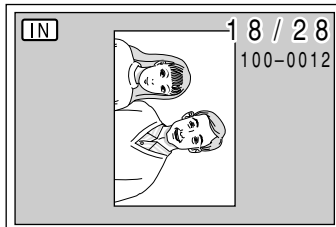



- Note**
- Only still picture files, text files, and still picture/text files with sound that have been recorded with this camera can be rotated.
 - The preset angle will be saved when the camera is turned off, enabling you to play files at the preset angle next time you turn the camera on.

Copying Image Files

Files can be copied from the internal memory onto a SmartMedia memory card or vice versa.



- When a protected file is copied, the copied file is unprotected.
- Only files taken with this camera can be copied.
- If there is not enough space available at the copy destination during copying, the [INSUFFICIENT MEMORY] message will be displayed. Press the shutter button to copy as many files as permitted by the available memory. Press the CANCEL button to cancel copy operation.

- ① Set the mode dial to  and press the MENU button.
- ② Press the  or  button to select [COPY] and press the ENTER button.

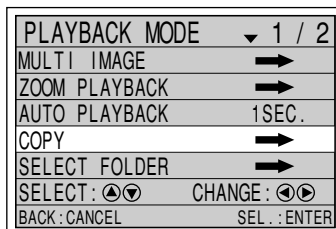

- ③ Press the ▲ or ▼ button to select the copy mode and press the ENTER button.

Operation varies depending on the copy mode. See:

- “Copying All Files” (p.84)
- “Copying Selected Files” (p.84)

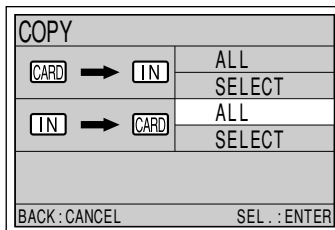

■ Copying All Files

- ① Press the shutter release button.

All the files will be copied and the display will return to the copy menu.

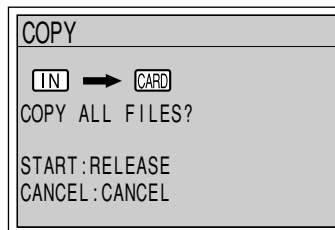

■ Copying Selected Files

- ① Press the ▲ or ▼ button and the ◀ or ▶ button to select the file to be copied and press the ENTER button.

The selected file will be indicated by the **C** mark. To select more files, repeat step ①.

Note To cancel a selection, press the ENTER button again and the **C** mark will disappear.

- ② Press the shutter release button.

The selected files will be copied and the display will return to the copy menu.

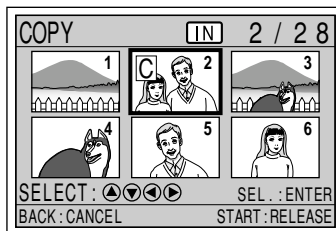



Playing a File Shot with a Non-Ricoh Camera

With certain exceptions, files recorded with a non-Ricoh camera can be played if the non-Ricoh camera conforms to the DCF* image file format.





* DCF is short for “Design rule for Camera File system” which is a set of specifications standardized by the Japan Electric Industry Development Association (JEIDA).

- 1 Insert a SmartMedia memory card, set the mode dial to [] and press the MENU button.

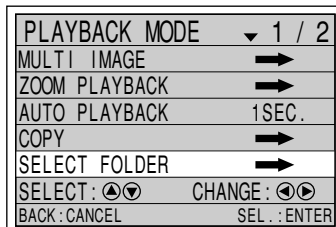
 • “Inserting a SmartMedia Memory Card” (p.28).

- 2 Press the  or  button to select [SELECT FOLDER] and press the ENTER button.



- 3 Press the  or  button to select a folder and press the ENTER button. The image files in the folder will be displayed. Press the  or  button to select a file to play.

 • “Playing Back a File” (p.76).

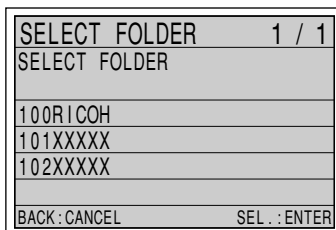



3 Playback





Protecting a File

You can protect important files from being erased accidentally.

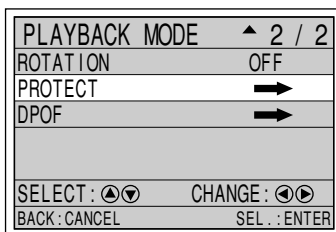
- 1 Set the mode dial to [] and press the MENU button.

- 2 Press the  or  button to select [PROTECT] and press the ENTER button.



- 3 Press the  or  button and the  or  button to select the file you wish to protect and press the ENTER button. The selected file will be indicated by the  mark. Repeat step 3 to select other files.

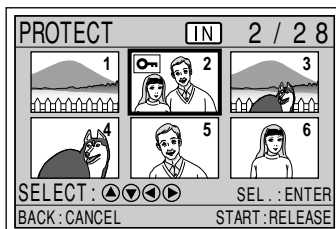

- Note** • To cancel a selection, press the ENTER button again and the  mark will disappear.

4 Press the shutter release button.

The files will be protected.

● How to Unprotect a File

Choose a protected file on the protect menu (step 3) and press the ENTER button. The  mark will disappear.

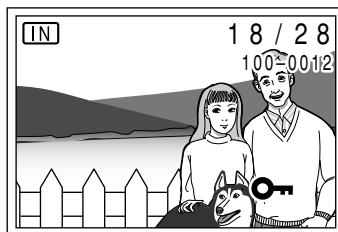

- Formatting the SmartMedia memory card or internal memory will erase protected as well as unprotected files.

Setting DPOF (Digital Print Order Format)

DPOF is a special feature built into your camera that allows you to assign information to your images for use by digital printing services, desktop printers that accept memory cards or devices that allow direct to print from your camera. By assigning DPOF information to an image, you may designate the quantity of images you wish to have printed or have an index of selected images printed directly from the memory card or image file.



When submitting recorded images to digital printing services or other applications, set the number of copies of the images to print and that of copies of the index. This setting is possible only when you select the RICOH folder.

Setting Printing Services

When submitting recorded files to a digital printing service, set the number of image prints and index prints that you require.



After setting, the recorded data can be printed by requesting a store with digital camera print service.

- Note**
- Only files in the RICOH folder can be set for digital printing services.
 - Be sure to leave enough free memory space for one or two files on the SmartMedia memory card when setting the printing service.
 - Once a printing service is set, never program record, erase or any other settings. If any setting is programmed, reprogram it.

① Set the mode dial to [] and press the  button to select , press the MENU button.

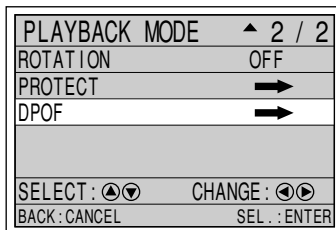
② Press the  or  button to select [DPOF] and press the ENTER button.



③ Press the  or  button to select the item you wish to set and press the ENTER button.

The procedure differs depending on the item you wish to set. See:

- “Specifying the number of prints” → (p.87)
- “Specifying the number of index prints” → (p.88)
- “How to Cancel the DPOF Settings” → (p.89)



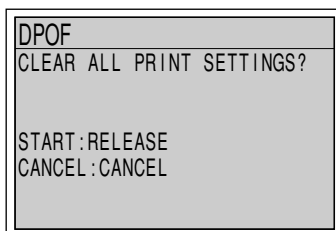
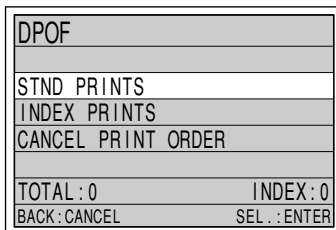

● If DPOF has already been set

If DPOF has already been set, the screen on the right will be displayed. Press the shutter button. New print settings are possible unless the previous settings are first cleared.



■ Specifying the number of prints

① Select [STND PRINTS] from the DPOF setting menu and press the ENTER button.

② Press the  or  button and the  or  button to select the file for which you wish to set the number of prints and press the ENTER button.

The selected file will be displayed as a single-image display.

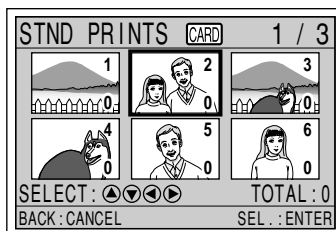

- Press the ▲ or ▼ button to specify the number of prints and press the ENTER button.

Note • To cancel the setting, set the number to zero.

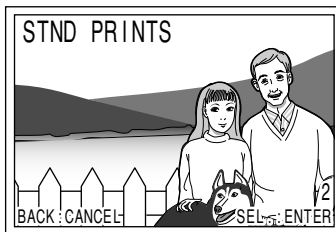

The number of prints will be set and the screen will return to the six-image display. To continue setting the number of prints, repeat steps ② and ③.

- Press the CANCEL button.

The screen will return to the DPOF setting menu.

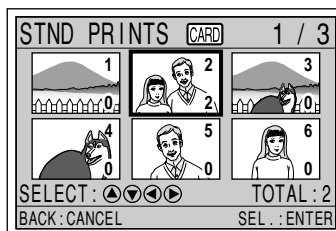

- Press the CANCEL button.

The screen will return to the playback menu.



- Turning the mode dial on the DPOF setting menu shown on the right will clear the setting. Be sure to press the CANCEL button to return to the playback menu.

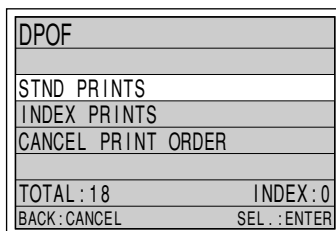

■ Specifying the Number of Index Prints

The index print feature allows all the files stored in the RICOH folder to be printed on a reduced scale. You can use the index print feature to list all the files recorded in the folder for visual confirmation or to specify the number of prints.

- Select [INDEX PRINTS] from the DPOF setting menu and press the ENTER button.

- 2 Press the ▲ or ▼ button to specify the number of index prints and press the ENTER button.

The display will return to the DPOF setting menu.

- Note** • To cancel the setting, set the index number to zero.

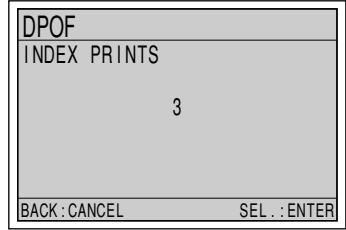

- 3 Press the CANCEL button.

The display will return to the playback menu.



- Be sure to press the CANCEL button to return to the playback menu. The setting will be canceled when turning the mode dial on the DPOF setting menu shown on the right.

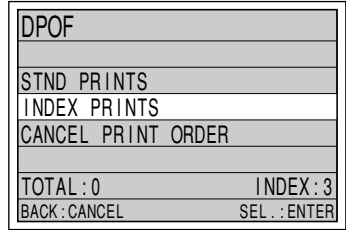

■ How to Cancel the DPOF Settings

- 1 Select [CANCEL PRINT ORDER] from the DPOF setting menu and press the ENTER button.
- 2 Press the shutter button.

All the DPOF settings will be cleared and the display will return to the playback menu.

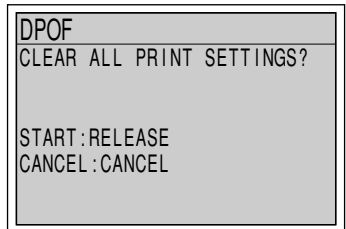

ERASING Chapter

4

Erasing Files	92
Erase Single Image	92
Erase All Images	93
Erase Selected Images	94

Erasing Files

This section explains how to erase recorded files. There are three ways to erase files:

- 1) ERASE SINGLE IMAGE for erasing one selected file at a time.
- 2) ERASE ALL IMAGES for erasing all files at once.
- 3) ERASE SELECTED IMAGES for erasing multiple selected files.







- Files cannot be restored once they are erased. Before starting to erase a file, make sure that you want to erase it.



- Files on a write-protected SmartMedia memory card cannot be erased unless the write protect pad is removed from the card. See “Protecting Against Accidental Writing” → (p.27).
- Only files that have been taken with this camera can be erased.
- Erasing time may vary depending on the capacity of the SmartMedia memory card and the type of file.

Erase Single Image

The selected file is erased.

- 1 Set the mode dial to [] and press the  button to select the erase source.
- 2 Press the  button.
- 3 Press the  or  button to select [ERASE SINGLE IMAGE] and press the ENTER button.

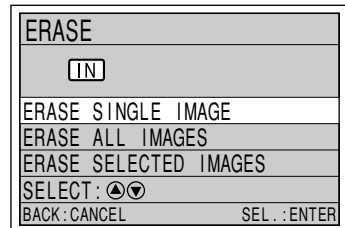
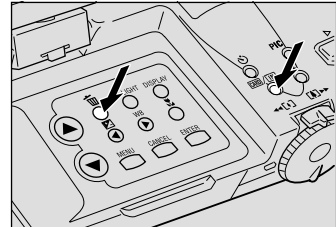

- ④ Press the ▲ or ▼ button to select the file to be erased and press the shutter release button.

The selected file will be erased. To erase more files, repeat step ④.

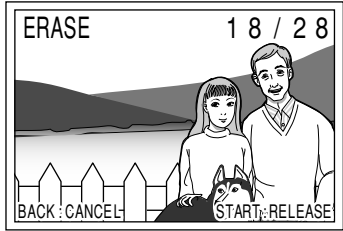



- ⑤ Press the CANCEL button.

The display will return to the erase menu.

- Note**
- When a file is erased, the subsequent file numbers are reassigned.
 - Protected files, which are identified by the  mark, cannot be erased until they are unprotected. See “Protecting a File” → (p.85).

Erase All Images

All recorded files in the folder are erased.

- ① Set the mode dial to [] and press the  button to select the erase source.

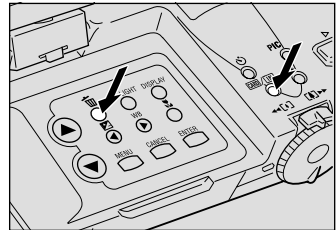

- ② Press the  button.

- ③ Press the ▲ or ▼ button to select [ERASE ALL IMAGES] and press the ENTER button.

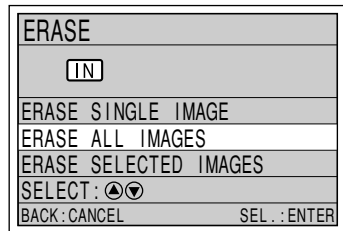

- ④ Press the shutter release button.

All the files will be erased and the display will return to the erase menu.

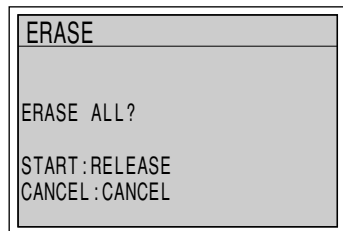



- Note**
- Protected files, which are identified by the  mark, cannot be erased until they are unprotected. See “Protecting a File” (p.85).

Erase Selected Images

Multiple selected files are erased.

❶ Set the mode dial to [] and press the **CARD/IN** button to select the erase source.

❷ Press the  button.

❸ Press the  or  button to select [ERASE SELECTED IMAGES] and press the **ENTER** button.

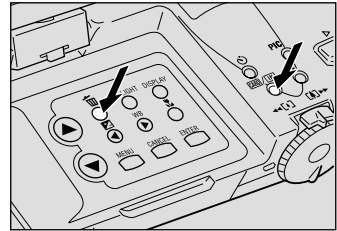

❹ Press the  or  button and the  or  button to select a file to be erased and press the **ENTER** button.

The selected file will be identified by the  mark. To select more files, repeat step ❸.

Note • To cancel selection, press the **ENTER** button again and the  mark will disappear.

❺ Press the shutter release button.

The selected files will be erased and the display will return to the erase menu.

Note • Protected files, which are identified by the  mark, cannot be erased until they are unprotected. See “Protecting a File” → (p.85).

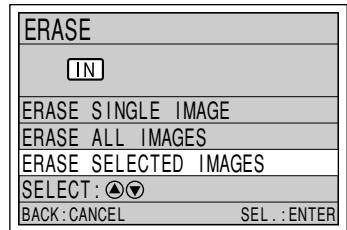

SETTINGS/MISCELLANEOUS Chapter

5

Transferring Images to a PC	96
Changing Camera Settings	98
Formatting a Card/Internal Memory	98
Keep Settings	99
Changing LCD Confirmation Time	100
Auto Power Off Setting	100
Beep Sound Setting	101
Power Save Mode Setting	101
File Numbering System	102
Changing Video-Out Signal Method (NTSC/PAL)	103
Changing Display Language	103
Initializing Settings	104
Using the Remote Control	105
Shooting	105
Playing	106
Erasing	107

Transferring Images to a PC

You can transfer recorded files to a personal computer by using a serial cable and software bundled with the camera.

Note • Refer to “Readme” file in the CD-ROM for installation and usage.

■ Installing Camera Utility Software

Install the CD-ROM based software (Camera utility Windows/Macintosh) (Ricoh Camera Utility) bundled with the camera.

■ PC Operating Platforms and installation instruction

● Windows

- Operation system : Windows® 95/98 NT4.0, Windows2000
- PC : PC running Microsoft Windows 95/98/NT4.0
Windows2000
- CPU : Pentium
- Memory : Windows95: 16MB (64MB or more recommended)
Windows98: 32MB (96MB or more recommended)
Windows NT4.0: 32MB (96MB or more recommended)
Windows2000: 64MB (96MB or more recommended)
- Hard disk drive space : 6 MB or more
- Display resolution : 640 × 480 dots more (recommended 800 × 600 dots or more)
(recommended 800 × 600 dots or more)
- Display colors : 256 or more (recommended 65,000 or more)
- Keyboard & mouse : Keyboard and mouse connectable to Microsoft Windows95/98/NT4.0/2000
- CD-ROM drive : CD-ROM drive supported by Microsoft Windows95/98/NT4.0/2000
- Quick Time : QuickTime 4.0 or later

● Macintosh

- Macintosh PC : Note or desktop
- CPU : PowerPC
- OS : Mac OS 8.1 – 9.0
- Internal memory : 64 MB or more (128MB or more recommended)
- Required memory : 16 MB of uncompressed application memory space or more (32 MB or more recommended)
- Hard disk drive space: 6 MB or more
- Display resolution : 640 × 480 dots or more (recommended 800 × 600 dots or more)

- Display colors : 256 or more (recommended 32,000 or more)
- Keyboard & mouse : Keyboard and mouse connectable to the Macintosh PC used
- CD-ROM drive : CD-ROM drive supported by the Macintosh PC used
- QuickTime : QuickTime 4.0 or later

Note • Install QuickTime 4.0 or later version to play moving play images on the PC.

■ Connecting the Camera to a PC

Use the interface serial cable with the RDC-7 to connect it to a personal computer.

- 1 Turn off the PC.
- 2 Turn off the camera.
- 3 Connect the camera and the PC using the interface cable.

Note • Avoid powering the camera on battery during connection to PC. If possible, run it via an AC adapter. Otherwise if the power shuts off while you are operating the camera, you would have to retry.

- Do not connect or disconnect the AC adapter to or from the AC outlet while the camera is turned on.

Typical Windows connection

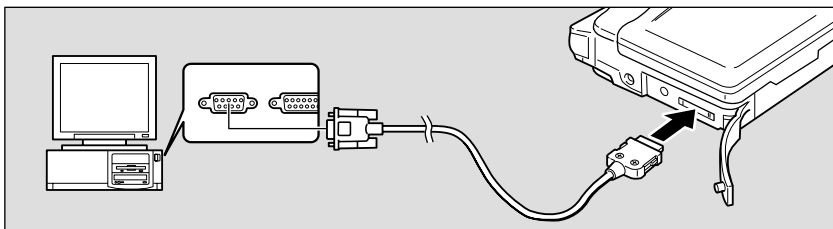

Typical Macintosh connection

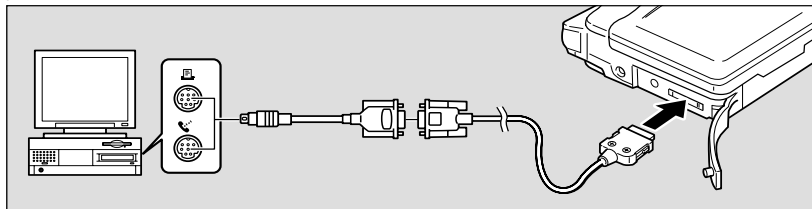

- 4 Turn off the camera and set mode dial to [SET], press the Δ or ∇ button to select [SERIAL TRANSFER] and press the ENTER button.
- 5 Turn on the PC and run the Utility software.

Changing Camera Settings

This section explains how to format (initialize) a SmartMedia memory card or the internal memory, and how to change the various settings such as auto power off, beep sound and keep settings.

Formatting a Card/Internal Memory

Follow the procedure below to format a SmartMedia memory card or the internal memory.

Before using a new SmartMedia memory card or a SmartMedia memory card that has been used on another device (such as a PC), you need to format it with the camera.

- 1 Set the mode dial to [SET].
- 2 Press the ▲ or ▼ button to select [FORMAT] and press the ENTER button.
- 3 Press the ▲ or ▼ button to select SmartMedia memory card or internal memory and press the ENTER button.

- 4 Press the shutter release button.
The "FORMATTING" message will be displayed. When formatting is completed, the display will return to the SET menu.

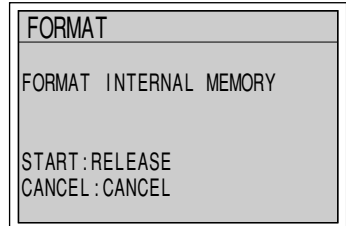
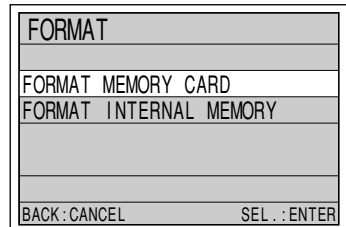
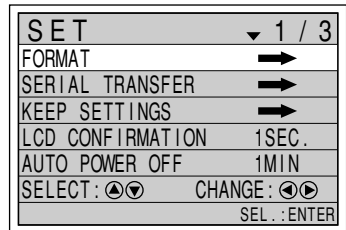

- Note** • A SmartMedia memory card with a write protect pad attached to it cannot be formatted. Remove the pad to format the SmartMedia memory card.



- Formatting a SmartMedia memory card or the internal memory will erase all the files recorded on the card or in the memory (including protected files). Copy any important files before formatting. See “Copying Image Files” → (p.83).
- SmartMedia memory cards formatted on another device may be unusable.

Keep Settings

The keep settings mode is for saving settings after the camera is turned off. The following settings can be saved.

- Flash (p.53)
- White Balance (p.57)
- Language (p.103)
- Focus (p.62)
- Flash Strength (p.55)
- +/- Exposure Compensation (p.56)
- Date Imprint (p.64)
- CARD/IN (p.42)
- ISO SENSITIVITY (p.64)
- Soft Mode (p.65)



- The red-eye reduction mode is also saved when the flash mode is saved.

- 1 Set the mode dial to [SET].
- 2 Press the or button to select [KEEP SETTINGS] and press the ENTER button.
- 3 Press the or button to select the item to be saved.
- 4 Press the or button to select [ON].
Keep Setting will be programmed. To program more items, repeat steps 3 and 4.

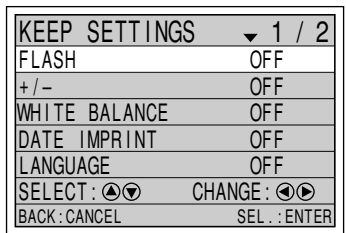
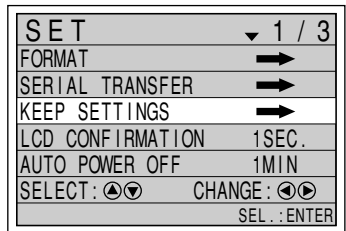









- To cancel the setting, select [OFF].



- 5 Press the ENTER button.
The display will return to the SET menu.

Changing LCD Confirmation Time

When you press the shutter button to take a picture in  (still picture) mode, the shot image appears on the LCD monitor. You can select the time for confirming the image after shooting from 0 sec., 1 sec., 2 sec., 3 sec., 4 sec. and 5 sec.





- 1 Set the mode dial to [SET].
- 2 Press the  or  button to select [LCD CONFIRMATION].
- 3 Press the  or  button to select the image confirmation time (0 SEC., 1 SEC., 2 SEC., 3 SEC., 4 SEC., 5 SEC.) and press the ENTER button.

SET	▼ 1 / 3
FORMAT	➡
SERIAL TRANSFER	➡
KEEP SETTINGS	➡
LCD CONFIRMATION	1SEC.
AUTO POWER OFF	1MIN
SELECT:  	CHANGE:  
SEL.:ENTER	





-  • If you select 0 sec. for the image confirmation time, the shot image will not be displayed on the LCD monitor.
- The shot image will be displayed until recording is completed, regardless of the preset image confirmation time, when in  (still picture) mode with sound, non-compressed (NC) or PRO (PRO, PRO-L, PRO-H) mode, or  (text) mode.

Auto Power Off Setting

The camera will turn off automatically (auto power off) in recording and play modes to conserve the battery if it is left idle (no buttons or switches operated) for the preset time. You can select from 1 min., 3 min., 5 min., and OFF for the time until the auto power off function is activated.

- 1 Set the mode dial to [SET].
- 2 Press the  or  button to select [AUTO POWER OFF].
- 3 Press the  or  button to select the preset time (1 MIN, 3 MIN, 5 MIN, OFF) and press the ENTER button.

If you select OFF, the auto power off function will be disabled.

SET	▼ 1 / 3
FORMAT	➡
SERIAL TRANSFER	➡
KEEP SETTINGS	➡
LCD CONFIRMATION	1SEC.
AUTO POWER OFF	1MIN
SELECT:  	CHANGE:  
SEL.:ENTER	

- Note** • Turn the power on again to reactivate the camera if it shuts off in auto power off mode.
- When using an AC adapter (option), the auto power off function is disabled even if you have set a time (except for interval shooting).

Beep Sound Setting

The camera beeps to alert you when it records a picture. You can enable or disable the beep by changing the setting.

- 1 Set the mode dial to [SET].
- 2 Press the ▲ or ▼ button to select [BEEP SOUND].
- 3 Press the ◀ or ▶ button to select [ON] or [OFF] and press the ENTER button.

If you select [OFF], the beep sound will be disabled.

SET	◆ 2 / 3
BEEP SOUND	ON
POWER SAVE MODE	ON
SEQUENTIAL NO.	OFF
DATE SETTING	2000 / 6 / 15
VIDEO OUT MODE	NTSC
SELECT : ▲▼	CHANGE : ◀▶
SEL. : ENTER	

- Note** • An error beep is not suppressed even when [BEEP SOUND] is set to [OFF].

Power Save Mode Setting

This mode is used to conserve power for the LCD monitor and extend the battery life.

- 1 Set the mode dial to [SET].
- 2 Press the ▲ and ▼ buttons to select [POWER SAVE MODE].
- 3 Press the ◀ or ▶ button to select [ON] or [OFF] and press the ENTER button.

SET	◆ 2 / 3
BEEP SOUND	ON
POWER SAVE MODE	ON
SEQUENTIAL NO.	OFF
DATE SETTING	2000 / 6 / 15
VIDEO OUT MODE	NTSC
SELECT : ▲▼	CHANGE : ◀▶
SEL. : ENTER	

- Note** • This mode is used to save 20% power consumption compared with the normal mode.

File Numbering System

When recording onto a SmartMedia memory card, you can choose whether the shot files will automatically be assigned consecutive numbers.

● When [SEQUENTIAL NO.] is [ON]

Numbers from R0010001 to R9999999 will be assigned to files.

As the camera saves the last number that was assigned, even when a new SmartMedia card is inserted, the subsequent number is assigned to the next image that is shot.

However, if the SmartMedia memory card contains a number that is bigger than the number saved by the camera, the next number after the one on the SmartMedia memory card will be assigned.

* Consecutive numbers will be assigned to files even if a different SmartMedia memory card is inserted. No file numbers will be duplicated.

* In some cases, file numbers on the same SmartMedia memory card may not be in consecutive order.

* To reset the numbering system, follow the procedures in “Initializing Settings” (p.104) and insert a SmartMedia memory card on which there are no images.

● When [SEQUENTIAL NO.] is [OFF]

Numbers from RIMG0001 to RIMG9999 will be assigned to files.

When a new SmartMedia memory card is inserted, numbering starts in sequence from RIMG0001. When a SmartMedia card on which files have been recorded is inserted, the next file is assigned the next number on the SmartMedia memory card.

* Numbering starts from RIMG0001 on each SmartMedia memory card.

* When the number RIMG9999 is reached, the [FILE NUMBER OVER] message is displayed and no more files can be recorded. See “Warning Messages” → (p.8).



- Numbering starts from RIMG0001 when the internal memory is selected as the recording destination.
- Using the consecutive numbering system (when [SEQUENTIAL NO.] is [ON]) is useful when submitting images to digital printing services or keeping files on a PC as there is no risk of the same number being assigned twice.

① Set the mode dial to [SET].

② Press the ▲ or ▼ button to select [SEQUENTIAL NO.].

③ Press the ◀ or ▶ button to select [ON] or [OFF] and press the ENTER button.

If you select [OFF], files will be assigned numbers starting from RIMG0001.

SET	◆ 2 / 3
BEEP SOUND	ON
POWER SAVE MODE	OFF
SEQUENTIAL NO.	OFF
DATE SETTING	2000 / 6 / 15
VIDEO OUT MODE	NTSC
SELECT : ▲▼	CHANGE : ◀▶
SEL. : ENTER	

Changing Video-Out Signal Method (NTSC/PAL)

Switches the video system for connecting the camera to a TV set to play record images on TV.

- Note** • “Connecting to a TV” (p.74) for instructions on how to connect the camera to a TV.
- “Using Your Digital Camera in Other Countries” → (p.117) for information about the television systems.

- 1 Set the mode dial to [SET].
- 2 Press the ▲ or ▼ button to select [VIDEO OUT MODE].
- 3 Press the ◀ or ▶ button to select [NTSC] or [PAL] and press the ENTER button.

The video setting will be changed.

SET	◆ 2 / 3
BEEP SOUND	ON
POWER SAVE MODE	OFF
SEQUENTIAL NO.	OFF
DATE SETTING	2000 / 6 / 15
VIDEO OUT MODE	NTSC
SELECT : ▲▼	CHANGE : ◀▶
SEL. : ENTER	

Changing Display Language

The information on the LCD monitor can be displayed in English, French, German and Japanese.

- 1 Set the mode dial to [SET].
- 2 Press the ▲ or ▼ button to select [LANGUAGE].
- 3 Press the ◀ or ▶ button to select the display language and press the ENTER button.

The language setting will be changed.

SET	▲ 3 / 3
LANGUAGE	ENGLISH
INITIALIZE SETTING	➔
SELECT : ▲▼	CHANGE : ◀▶
SEL. : ENTER	

- Note** • Enable the keep settings mode to save the display language setting. See "Keep Settings" → (p.99).

Initializing Settings

You can reset all settings except the date.



- Data set by Keep Settings will also be initialized to its factory default settings.

① Set the mode dial to [SET].

② Press the ▲ or ▼ button to select [INITIALIZE SETTING] and press the ENTER button.

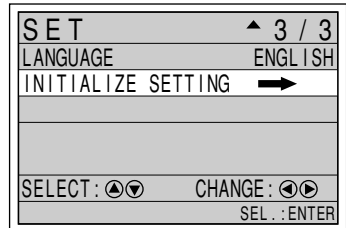

③ Press the shutter release button.

The settings will be reset to their factory default settings and the display will return to the SET menu.

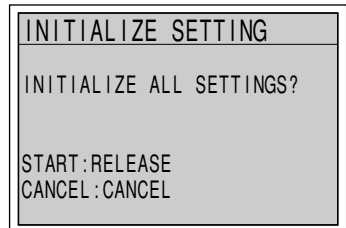

- Recorded files are preserved intact even when the settings are initialized.

Using the Remote Control

This section explains how to operate the camera using the optional DR-3 remote control unit.



- The remote control receiver is located at the upper left of the LCD monitor. Operate the remote control unit by pointing it at the LCD monitor.



- For instructions on replacing the batteries and maintaining the remote control unit, refer to the accompanying manual.
- Some procedures differ when performed on the remote control unit and on the camera itself. Follow the instructions below to use the remote control unit.

Shooting

The remote control unit can be used to operate the camera. It is particularly convenient when the camera is set up at a remote location or is in a fixed position.

- 1 **Set the mode dial to shooting mode** (• • • •) and press the **CARD/IN** button to select the recording destination.

- 2 **Decide the composition of the picture and press the RELEASE button.**

- In (still picture)

The self-timer LED will light and recording will start about 2 seconds later.

- (text) mode

Shooting will be done shortly.



- In (continuous shooting) mode

Shots will be taken continuously while the RELEASE button is pressed. Shooting will stop when the RELEASE button is released and the shots will be recorded.

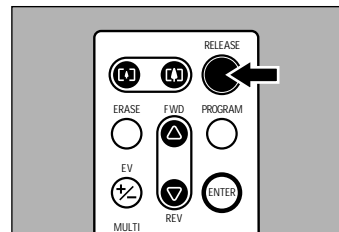

- In (sound)/ (motion picture) mode

Recording of the sound and image will start when the RELEASE button is pressed. Recording will stop when the RELEASE button is pressed again and the shots will be recorded.





- Note • Use the zoom button to vary the size of the subject. Press the  zoom button to magnify the subject and press the  zoom button to decrease the size of the subject.

■ Setting Exposure Compensation

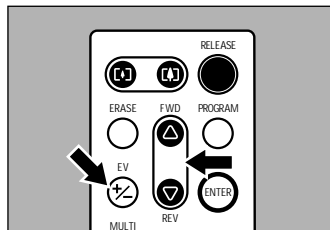
- 1 Press the EV (+/-) button.
- 2 Set the exposure compensation level using the FWD () or REV () button and press the ENTER button.
Press the RELEASE button to take the picture.



■ Shooting in Manual Focus Mode



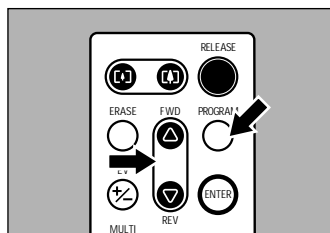

- 1 Press the PROGRAM button.
The manual focus mode will be activated.
- 2 Press the FWD () or REV () button to adjust the focus.
Press the RELEASE button to take the picture.



- **How to Cancel Manual Focus Mode**
Press the PROGRAM button again.

Playing

Use the remote control unit to play back recorded files.

- 1 Set the mode dial on the camera to  and press the / button to select the playback source.
The most recently recorded file will be played.
- 2 Press the FWD () or REV () button to select a file.
The remote control unit buttons are operated in the same way as the buttons on the camera.

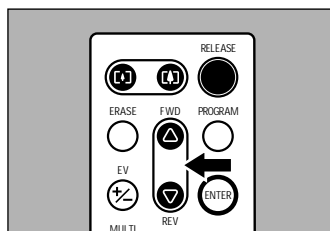

■ Magnifying an Image (Zoom Playback)

① Press the PROGRAM button.

The image will be displayed in zoom playback.

② Press the [▲] or [▼] button and the FWD (△) or REV (▽) button to shift the playback position.

Depending on the image size, you can change the magnification by pressing the ENTER button. See “Zoom Playback” → (p.81).

● How to Cancel Zoom Playback Mode

Press the PROGRAM button.

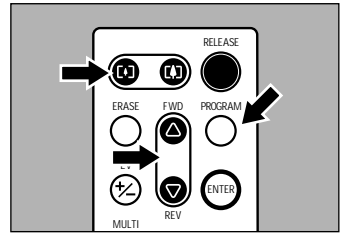

■ Displaying Multiple Images (Multi Image Playback)

① Press the MULTI button.

The image will be displayed in Multi playback.

② Press the [▲] or [▼] button and the FWD (△) or REV (▽) button to move the selected image.

③ Press the ENTER button.

The selected image will be displayed in single-image mode and multi-image playback mode will be canceled.

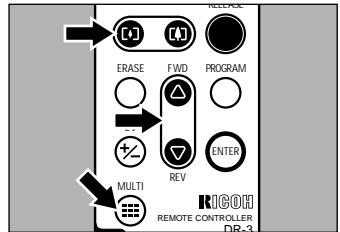

Erasing

You can use the remote control unit to erase a recorded file.



- Remember that files cannot be restored once they are erased. Before starting to erase files, make sure that you want to erase them.

① Set the mode dial on the camera to [▶] and press the [CARD/IN] button to select the erase source.

② Press the ERASE button.

The erase menu will be displayed.

- Use the FWD (Δ) or REV (∇) button to select [ERASE SINGLE IMAGE] and press the ENTER button.

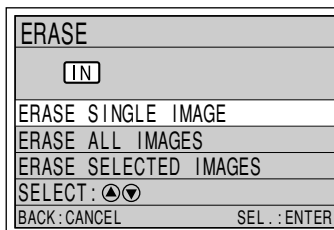

- Use the FWD (Δ) or REV (∇) button to select the file to be erased and press the RELEASE button.

The selected file will be erased.

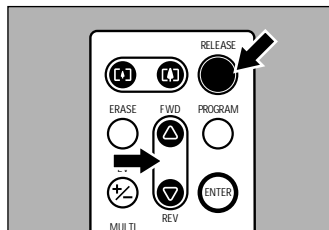

■ Erasing All Files

- Select [ERASE ALL IMAGES] on the erase mode screen (step 3).

- Press the RELEASE button.

All the files will be erased.

Note • To cancel operation, press the CANCEL button on the camera.

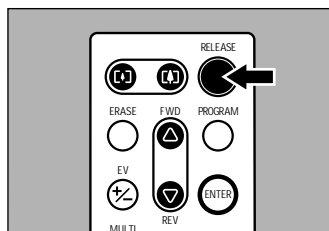

■ Erasing Selected Images

- Select [ERASE SELECTED IMAGES] on the erase mode screen (step 3).

- Use the [A] or [B] button and the FWD (Δ) or REV (∇) button to select the file to be erased and press the ENTER button.

Note • To cancel selection, press the ENTER button again.

- Press the RELEASE button.

Note • To cancel operation, press the CANCEL button on the camera.

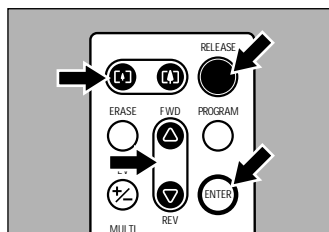

APPENDIX

Accessories	110
Handling Precautions	111
Care and Storage	112
Troubleshooting	113
Using Your Digital Camera in Other Countries	117
About the Warranty and Servicing	118
Specifications	120
Recording Capacities	122

Accessories

Item	Model	Remarks	
AC Adapter	AC-3	For drawing power directly from a household electrical outlet. See "Using an AC Adapter" (p.26).	
Lithium ion battery	DB-20	The camera body battery.	
Remote Control Unit	DR-3	For remote operation of the camera's recording and playback functions.	
SmartMedia Memory Card		A postage stamp-sized recording media with a thickness of 0.76 mm.	
	4 M	FS-4	Capable of recording a maximum of about 19 images in 1024N mode.
	8 M	FS-8	Capable of recording a maximum of about 39 images in 1024N mode.
	16 M	FS-16	Capable of recording a maximum of about 76 images in 1024N mode.
	32 M	FS-32	Capable of recording a maximum of about 153 images in 1024N mode.
PC Card Adapter	FS-B53	Used to insert the SmartMedia memory card directly into the PC card slot.	
Floppy Disk Adapter	FS-B10	Used to insert the SmartMedia memory card directly into the PC floppy disk drive.	

- Microsoft, MS and Windows are registered trademarks of Microsoft Corporation in the United States of America and other countries.
- Macintosh is a registered trademark of Apple Computer, Inc., in the United States of America and other countries.
- SmartMedia™ is a registered trademark of Toshiba Inc.
- All trademarked company and product names mentioned in this manual are the property of their respective owners.

Handling Precautions

- This camera is not waterproof. Keep away from water, rain, beverages, etc. Consult your nearest Ricoh service office if any liquid gets into the camera.
- Be careful not to drop the camera or subject it to impact.
- To avoid overheating, do not use the flash more than necessary in continuous shots.
- Never look through the viewfinder directly at the sun or intense light.
- Do not fire the flash close to an infant's eyes as this may result in impaired eyesight.
- Do not fire the flash into the eyes of someone driving a vehicle as this may result in a traffic accident.
- Exercise caution to prevent sand or dust from getting into the camera in such environments as beaches or work sites.
- Do not leave the camera for any length of time in particularly hot or humid places, such as an automobile with the windows closed, beaches or bathrooms.
- Verify that the camera power is off before you attach the AC adapter.
- The LCD monitor or the LCD panel may contain some pixels that always or never illuminate and the brightness of some areas of the monitor may appear uneven. These are typical LCD performance characteristics and do not constitute malfunctions.
- Do not force the card door, terminal cover or battery cover.
- Do not lift the camera by the LCD monitor, card door, terminal cover or battery cover.
- Do not apply unreasonable force when opening or turning the LCD monitor.
- Be careful not to hit the lens unit or the LCD monitor while carrying the camera. Make sure to close the LCD monitor when carrying the camera.
- Extreme temperature differences may cause condensation to form inside the camera body and lens unit, reducing performance. To avoid this, place the camera in a plastic bag and let it slowly acclimatize to the new temperature before exposing it.

Potential Causes of Condensation

- Suddenly moving the camera from a cold place to a warm place.
- Storing or using the camera in place subject to high humidity.
- Bringing the camera into a recently heated room or leaving it directly in the path of air conditioning.

Care and Storage

■ Care

- Fingerprints or dirt on the lens or AF viewfinder will reduce the image quality so take extra care not to get it dirty.
- Do not wipe dust or smears off the lens or AF viewfinder with your fingers. Use a lens blower, available at most photographic suppliers, to blow dust off, or a soft cloth to wipe it lightly.
- Be particularly diligent in cleaning the lens after use at the beach or in the vicinity of chemicals.
- If your camera should malfunction, take to your nearest Ricoh service office. This product generates high voltage and disassembly is hazardous. Under no circumstances should you attempt to disassemble it yourself.
- Never use solvents, benzene, insecticides or other volatile substances on the equipment as this may deform or dissolve it.
- Be careful not to let objects rub against the LCD monitor or the LCD panel as they are easily scratched.
- To clean the LCD monitor or the LCD panel, wipe it gently with a soft cloth moistened with diluted detergent and well-wrung. Wipe off any moisture with a soft, dry cloth.
* Remove the battery and AC adapter from the camera before commencing any of the above.

■ Storage

To prevent possible failures, avoid storing the camera in places that are:

- Hot and damp, or subject to sharp temperature or humidity changes.
- Sandy or dusty.
- Subject to strong vibration.
- In contact with chemicals, such as insecticides, or rubber or PVC products for extended periods of time.
- Near sources of strong electromagnetism (such as monitors, transformers, and magnets).

Troubleshooting















Refer to the items listed below before submitting the equipment for repairs. If the problem persists, contact your nearest Ricoh service center.

■ Power Source

Symptom	Cause	Remedy	Page
Power will not come on	Battery expired, improperly inserted or not loaded	Insert the battery correctly or charge the battery	P.23 P.24
	AC adapter not attached correctly	Attach correctly	P.26
	Card door open	Close the card door and turn power on again	P.41
Power cuts out	No buttons touched so auto power off function was activated	Turn power on again	P.41
	Battery expired	Charge battery	P.23
Battery will not charge	End of battery life	Replace with new battery	P.24
Battery quickly consumed	Camera operated in extremely high or low temperature location	–	P.25
	Camera operated in dark area requiring frequent use of flash	–	–





■ Recording and Playback

Symptom	Cause	Remedy	Page
Shutter release button pressed but no image recorded	Battery expired, improperly inserted or not loaded	Insert battery correctly or recharge battery	P.23 P.24
	Power is not turned on or mode dial is not set	Turn power on and set mode dial to shooting mode	P.41
	Shutter release button only pressed halfway	Press shutter release button all the way	P.46
	SmartMedia memory card not formatted	Format SmartMedia memory card	P.98
	No space on SmartMedia memory card	Erase unwanted files or insert new SmartMedia memory card	P.28 P.92
	No space in internal memory	Erase unwanted files	P.92
	End of service life of SmartMedia memory card	Insert new SmartMedia memory card	P.28
	Card door open	Ensure that card door is securely closed.	P.28
	Self-timer on	Press  button to disable the self-timer	P.59
	Flash is charging	Wait until flash LED ceases flashing	P.46
SmartMedia memory card contact surface dirty	Clean contact surface with soft dry cloth	P.27	
Cannot confirm a shot picture	Image confirmation time is too short	Set a longer image confirmation time	P.100
No image on the LCD monitor	Power is off, or LCD monitor is dark	Turn power on and open LCD monitor, or adjust brightness of the LCD monitor	P.41 P.104
	Video system is set on PAL and video cable is still plugged in	Set video system to NTSC or disconnect video cable	P.74 P.103

Symptom	Cause	Remedy	Page
Autofocus is on but camera not focusing	Dirty lens	Clean lens	–
	Subject not in center of autofocus field	Use focus lock	P.61
	Subject difficult to focus	Use focus lock or switch to manual focus	P.61,62
Flash will not fire or will not charge	Shooting mode is set to  (sound),  (continuous) or  (moving image)	Set mode dial to  (still picture) or  (text) mode	P.41 P.49
	Flash is set to  (flash off) mode	Press  button to cancel flash off mode	P.53
	Mode dial is set to macro mode	Press  button to cancel macro mode	P.60
	White balance set to mode other than auto	Press WB button to set white balance to auto	P.57
	Battery expired	Charge battery	P.23
	Image dark even with flash	Subject farther than approx. 3.0m with zoom on telephoto or approx. 3.4m with zoom on wide angle	Come closer to subject
Image is too bright	Camera is too close to subject	Set flash to flash off mode	P.53
	Overexposed	Press  button to change exposure compensation level	P.56
	Brightness setting needs adjusting	Press LCD LIGHT button to adjust brightness of LCD monitor	P.104
Image is too dark	Shot in low light area with camera set to  (flash off) mode	Press  button to cancel flash off mode	P.53
	Under-exposed	Press  button to change exposure compensation level	P.56
	Brightness setting needs adjusting	Press LCD LIGHT button to adjust brightness of LCD monitor	P.104
Unnatural coloration of image	Shooting conditions difficult to achieve white balance in auto mode	Place a white object near the subject, use the flash or select a white balance mode other than auto	P.53 P.57
Date and other recording data will not display	Screen display set to off	Press DISPLAY button to switch screen display mode	P.48 P.79
Cannot play back or image will not appear	Camera not set to  (play) mode	Set mode dial to  (play)	P.76
	Wrong playback source	Press  button to change playback source	P.76
	SmartMedia memory card not inserted or does not contain any files	Insert SmartMedia memory card with recorded images	P.28
	Attempted to play SmartMedia memory card not formatted with this camera	Use SmartMedia memory card that has been formatted and recorded on this camera	P.28
	SmartMedia memory card contains incorrectly recorded files	Insert SmartMedia memory card containing pictures properly recorded with this camera	P.28
	SmartMedia memory card contains files in format not read by this camera	Check format type	P.74
	Card door open	Ensure that card door is securely closed	P.28
	Video interface cable not correctly connected	Check connection	P.74
	Source of interference, such as electric motor, nearby	Relocate camera away from interference source	–
	SmartMedia memory card contact surface dirty	Clean contact surface with soft dry cloth	P.27

Symptom	Cause	Remedy	Page
Replay is not clear	Error in internal memory of camera	Copy required files from internal memory onto SmartMedia memory card and format internal memory	P.83 P.98
	Error in SmartMedia memory card in usecard	Test camera with another SmartMedia memory card. If second card displays well, problem is with card not camera.	–
Display shuts off	Battery expired	Charge battery	P.23
	Auto power off activated	Turn power on again	P.41
Remote control unit will not work	Obstruction between remote control unit and camera sensor	Remove obstruction *Sensor is on upper left of LCD monitor	–
	Dirty remote control transmitter or camera sensor	Clean with soft dry cloth	–
	Remote control battery expired	Replace CR2032 lithium battery	–
LCD monitor brightness changes during AF operation	Area captured by autofocus field and surrounding area are contrasting	There is no malfunction	–
Vertical lines appear on image	A light level or entire subject is dark. Phenomenon occurring with pictures of bright subject, known as smudge phenomenon	There is no malfunction	–

■ Miscellaneous

Symptom	Cause	Remedy	Page
SmartMedia memory card will not fit into slot	Wrong type of SmartMedia memory card	Use a SmartMedia memory card specified for the camera	P.28
	SmartMedia memory card incorrectly oriented	Insert the SmartMedia memory card the correct way	P.28
Camera will not operate even when buttons and switches are operated	Battery expired	Charge battery	P.23
	Camera malfunction	Turn power off and on once. Set the mode dial to  (still picture) or  (text). If the problem persists, reset the camera. 1. Remove the battery, turn the power on, then reload the battery. 2. Try operating the camera again.	—
Date and time are wrong	Date and time setting is incorrect	Set the correct date and time	P.34
Date and time were set but disappeared	Battery has been removed	The date setting is reset if the battery has been removed for about 1 month. Set the date again.	P.34
File will not erase or SmartMedia memory card will not format	Camera not set to erase mode	Set the mode dial to  (play) and press the  button.	P.92
	Write protect pad on SmartMedia memory card	Remove the pad from the SmartMedia memory card	P.27
	Protected file	Use the play menu to cancel the protect setting	P.85
	Power is turned off or auto power off activated	Turn the power on again	P.98
Mode settings have changed	Battery has been removed	Reset mode	P.98
Auto power off will not activate Beep will not sound	Auto power off setting is disabled	Enable setting	P.100
	Camera powered by AC adapter (auto power off is automatically disabled when powered by an AC adapter)	—	—
	Beep disabled	Set beep sound to [ON] on the SET menu.	P.101
No image on TV screen	TV system setting is incorrect	Select correct TV system	P.103

Using Your Digital Camera in Other Countries

Ricoh AC-3 AC Adapter (optional)

- The AC-3 AC adapter adjusts automatically to voltages ranging from 100V to 240V and frequencies of 50Hz to 60Hz.
- Some countries use electrical outlets which have different shapes. Before leaving on a trip, obtain the necessary plug adapter from a travel agent or electric store.

Using a Local TV Receiver for Playing Pictures

- You can play pictures taken with this camera on a TV receiver (or monitor) equipped with a video input terminal. Use the video interface cable supplied.
- This camera supports two television systems: NTSC and PAL. Switch your camera's video system to meet the local television environment. See "Changing Video System" → (p.103).
- If you plan to take the camera with you on a trip abroad, identify the local television system beforehand.

About the Warranty and Servicing

1. The Ricoh RDC-7 camera is backed by a one-year limited warranty. During the warranty period, which starts from the date of purchase, any defective parts will be repaired free of charge. In the event of a camera malfunction, contact the dealer from which you purchased the camera or contact your nearest Ricoh service office. Please note that you will be liable for any costs incurred in taking the camera to the Ricoh service office.
2. This warranty does not cover any damage resulting from:
 - ① Failure to follow the instructions in the instruction manual;
 - ② Repair, modification or overhaul not conducted by an authorized service center specified in the instruction manual;
 - ③ Fires or natural disaster;
 - ④ Improper storage, such as exposing the camera to high temperatures, humidity, or insecticide; storing it with a leaking battery; storing the camera in a dirty condition so that it becomes moldy; or otherwise insufficiently caring for the camera.
 - ⑤ Submergence; exposure to floods or spilled alcoholic or other beverages; allowing sand or mud to enter the camera; exposure to physical shocks; or dropping of the camera.
3. After a full year has passed from the purchase date, you will become liable for all repair fees, including those incurred at an authorized service center.
4. You will be liable for all repair fees, even within the warranty period, if the warranty card is not attached or if the distributor's name or the purchase date has been changed or is not indicated on the card.
5. Expenses for overhauls and thorough inspections as a result of a customer's special request will be charged to the customer, whether or not they are incurred during the warranty period.
6. This warranty only applies to the camera and not to the accessories, such as the case and wrist strap, nor does it apply to the consumables provided, such as batteries.
7. Any consequential damage arising from the failure of this camera, such as expenses for taking pictures or loss of expected profit, will not be reimbursed whether it occurs during the warranty period or not.
8. The above provisions refer to repairs offered free of charge, and do not limit your legal rights. The intention of the above provisions is also described in the warranty card provided with this camera.

9. Parts essential to the servicing of this camera - that is, components required to maintain the functions and quality of this camera - will be available for a period of seven years after the camera is discontinued. However, as some of those parts are kept for a longer period, do not hesitate to contact your distributor or nearest Ricoh service representative even after the seven year period.
10. Please note that if the camera is seriously damaged by flooding, submergence, infiltration of sand or mud, violent shocks or dropping, the camera may not be repairable, and restoration of its original condition may be determined to be impossible.

- Note**
- Before submitting the camera for repair, check the battery and read this instruction manual again to ensure proper operation.
 - Some repairs require a significant amount of time to be completed. Please allow sufficient time for repairs.
 - When sending the camera to a service representative, please include a note which describes the defective part and the problem as precisely as possible.
 - Remove all accessories not related to the problem before sending the camera to a service representative.
 - Before taking any important pictures (such as at weddings, on trips abroad, etc.), test the camera to check its operation and ensure proper functioning. We recommend that you keep this manual and a spare battery on hand.

Specifications

■ General

- **Video Signal Protocol** : NTSC/PAL
- **Power Source Voltage** : Battery: 3.7V
AC: 5V
- **Dimensions** : 135.4 × 74.0 × 26.6 mm (5.3 × 2.9 × 1 in.)
- **Mass** : Approx. 270 g (9.5 oz) (excluding battery)
- **Operating Temperature Range** : 0°C to 40°C (32°F – 104°F)
- **Operating Humidity Range** : 85% or less
- **Storage Temperature Range** : -20°C to 60°C (-4°F – 140°F)

■ Camera

- **CCD** : 3,340,000 pixels (effective: 3,240,000 pixels)
- **Lens** : Zoom lens F=2.6 – 3.4
 - **Focal length** : f=7.3 - 21.9 mm (equivalent to 35 - 105 mm in 35mm camera format)
 - **Minimum shooting range** : Approx. 24 cm (9.4 in) (wide angle)
 - **Macro shooting range** : Approx. 1 - 24 cm (0.4 in – 9.4 in)
- **Viewfinder**
 - **Type** : Real image
 - **Magnification** : Tele 0.81X, wide 0.3X
 - **Parallax correction** : Yes (-2 - +1 dpt)
- **Monitor**
 - **Display size** : 2.0"
 - **Drive system** : TFT Active Matrix System
 - **No. of pixels** : Approx. 200,000
- **White Balance** : Auto/Preset (Daylight, Cloudy, Tungsten Light, Fluorescent Light)
- **Exposure Compensation**
 - **Light metering system** : Centerweighted
 - **Exposure memory mechanism** : Auto backlighting compensation
Manual exposure compensation ±2.0 EV (in 0.5 EV increments)
 - **Metering system** : TTL-CCD
 - **Flash automatic exposure** : Yes (daylight synchro)
 - **Shutter speed** : 1- 1/1000 in still picture mode
 - **ISO sensitivity** : ISO Approx. equivalent to 150 (AUTO)
- **Distance Adjustment**
 - **Autofocus system** : Normal shooting domain: TTL-CCD, macro domain: CCD
 - **Autofocus range** : Normal shooting domain: approx. 24 cm - ∞ (9.4 in - ∞),
macro domain: 1 - 24 cm (0.4 – 9.4 in.)
- **Built-in Flash**
 - **Type** : Auto
 - **Range** : Approx. 0.6 - 2.5 m (2.0 ft – 8.2 ft)
 - **Modes** : Off/Forced flash/Slow synchro/Auto/Red-eye reduction

■ Image Data Recording and Playback

● Resolution

- Still picture mode : 2048 × 1536, 1024 × 768, 640 × 480, 3072 × 2304 (PRO) pixels
- Text mode : 2048 × 1536, 1024 × 768, 3072 × 2304 (PRO) pixels
- Moving image mode : 320 × 240 pixels

● File Format

- Still picture mode : Compressed: JPEG (Exif2.1), Non-compressed: TIFF (Exif2.1)
- Text mode : TIFF (G4 MMR)
- Moving image mode : AVI (conforms to Open DML Motion JPEG format)
: WAV (Exif2.1)

● Camera File System Standard

: DCF (Design rule for Camera File system standardized by JEIDA)

● Compression Format

: JPEG baseline system

● File Sizes

- 2048 × 1536 : F: approx. 1.12 MB, N: approx. 568 KB, E: approx. 280 KB, NC: approx. 6 MB
- 1024 × 768 : F: approx. 376 KB, N: approx. 184 KB, E: approx. 88 KB, NC: approx. 1.5MB
- 640 × 480 : F: approx. 152 KB, N: approx. 72 KB, E: approx. 40 KB, NC: approx. 640 MB
- 3072 × 2304 (PRO) : F: approx. 2.53 MB, N: approx. 1.26 MB, E: approx. 648 KB, NC: 13.5 MB

■ Input/Output Terminal

● Power Input

: 5 V (AC adapter)

● Video Output

: 1.0 Vp-p (75 Ω)

● RS-232C/AUX/USB

: For connecting to a PC

■ Body

● Tripod Screw Hole

: Yes (1/4-20 UNC)

: Less than 6.0 mm

■ Power Supply

● Main Battery

• Type

: Rechargeable lithium ion battery

• Voltage

: 3.7 V

■ Date Retention Time

: Approx. 1 month

■ Auto Power Off

: Off/Activated after more than 1 min., 3 min. or 5 min.

■ Internal Memory

• Capacity

: 8 MB

■ Compatible Memory Cards for Recording and Playback

● Type of Memory

: SmartMedia memory card

• Capacity

: 2, 4, 8, 16, 32, 64 MB

• Operating voltage

: 3.3 V

Recording Capacities

The table below gives approximate recording picture counts available by SmartMedia memory card capacity and by picture quality/size.

			2MB	4MB	8MB	16MB	32MB	64MB
Still picture Mode (No. of images)	PRO	F	0	1	3	6	12	24
		N	1	3	6	12	24	48
		E	3	6	12	24	48	97
		NC	0	0	0	1	2	4
	2048	F	1	3	6	13	27	54
		N	3	6	13	26	53	107
		E	6	13	26	42	105	210
		NC	0	0	1	2	5	10
	1024	F	5	10	20	39	79	159
		N	9	19	39	76	153	307
		E	19	38	76	142	285	570
		NC	1	2	5	10	20	40
	640	F	12	24	49	99	199	399
		N	23	45	90	166	332	665
		E	41	82	165	332	665	1331
		NC	3	6	12	24	49	99
Text Mode (No. of images)	PRO	3	6	12	24	48	97	
	2048	6	13	26	52	105	210	
	1024	19	38	76	142	285	570	
Motion Picture Mode (Seconds)			10	20	41	82	166	332
Sound Mode (Minutes)			252	505	1017	2037	4085	8179

* Sizes (no. of pixels) are as follows.

PRO : 3072 × 2304 pixels

2048 : 2048 × 1536 pixels

1024 : 1024 × 768 pixels

640 : 640 × 480 pixels

* Image quality (compression rate) is as follows.

F : Fine

N : Normal

E : Economy

NC : Non-compressed

* Units are as follows.

For still picture files and text files: number of images.

For moving image files: number of seconds.

For sound files: number of minutes.



- Even when “1” is displayed as the number of recordable picture in the Text mode, recording may not be possible in some cases, depending on the subject.
- The internal memory is similar to an 8 MB SmartMedia memory card.



Declaration of Conformity

“The Product complies with the requirements of the EMC Directive 89/336/EEC.”

INFORMATION TO THE USER

USA FCC Part15 Class B

The equipment has been tested and found to comply with the limits for a Class B digital device, pursuant to part 15 of the FCC Rules. These limits are designed to provide reasonable protection against harmful interference in a residential installation. This equipment generates, user, and can radiate radio frequency energy and if not installed and used in accordance with the instructions, may cause harmful interference to radio communications. However, there is no guarantee that interference will not occur in a particular installation. In this equipment does cause harmful interference to radio or television reception, which can be determined by turning the equipment off and on, the user is encouraged to try to correct the interference by one or more of the following measures:

- Reorient or relocate the receiving antenna.
- Increase the separation between the equipment and receiver.
- Connect the equipment to outlet on a circuit different from that to which the receiver is connected.
- Consult the dealer or an experienced radio/TV technician for help. (FCC 15.105B)

Changes or modifications not expressly approved by the party responsible for compliance could void the user's authority to operate the equipment. (FCC 15.21)
Properly shielded and grounded cables and connectors must be used for connection to a host computer in order to comply with FCC emission limits. (FCC 15.27)
An AC adapter with a ferrite core must be used for RF interference suppression.

COMPLIANCE INFORMATION STATEMENT

Product Name: IMAGE CAPTURING DEVICE

Model Number: RDC-7

This device complies with Part 15 of the FCC Rules.

Operation is subject to the following two conditions:

- (1) This device may not cause harmful interference, and
- (2) This device must accept any interference received, including interference that may cause undesired operation.

RICOH CORPORATION

5 Dedrick Place, West Caldwell NJ, 07006 Tel.: 1-800-225-1899

Note to Users in Canada

Note: This Class B digital apparatus complies with Canadian ICES-003

Remarque Concernant les Utilisateurs au Canada

Avertissement: Cet appareil numerique de la classe B est conforme a la norme NMB-003 du Canada

IMPORTANT SAFETY INSTRUCTIONS-SAVE THESE INSTRUCTIONS DANGER-TO REDUCE THE RISK OF FIRE OR ELECTRIC SHOCK, CAREFULLY FOLLOW THESE INSTRUCTIONS.

Ricoh Service Offices

Ricoh Co., Ltd.
Ohmori NM Building
1-1 Ohmori-Kita 2-chome
Ota-ku, Tokyo
143-0016 JAPAN
<http://www.ricoh.com>

Ricoh Factory Service Center
3235 Sunrise Blvd.,
Suite2 Rancho Cordova,
CA 95742
<http://www.ricohcpg.com/>

Ricoh Europe B.V.
Photo Products Division
P.O. Box 75640
1118 ZR Schiphol
The Netherlands
<http://www.ricoh-red.com/>
<http://www.ricoheurope.com/>
E-mail:camera@ricoh.nl

Ricoh Europe B.V. Düsseldorf Branch
Photo Products Division
Oberrather Straße 6,
D-40472 Düsseldorf,
Germany

Ricoh Photo Products (Asia), Ltd.
Unit D, E & F
24/F., China Overseas Building
139 Hennessy Road, Wan Chai
Hong Kong

Ricoh Australia Pty. Ltd.
8 Rodborough Road
Frenchs Forrest, N.S.W. 2086
Australia
<http://www.ricoh-aust.com.au>



RICOH CO., LTD.
Ohmori NM Building
1-1 Ohmori-kita 2 chome
Ota-ku, Tokyo
143-0016 Japan
L2112546A

